

# **APPLICATION GUIDELINES**

## **POTABLE WATER TANKS**

**Interline<sup>®</sup> 925**

**Revision 16**

**Issue Date: 02<sup>nd</sup> May 2017**

### **Marine Coatings**

All products supplied and technical advice or recommendations given are subject to our standard Conditions of Sale.

Registered in England No. 63604

Registered Office The AkzoNobel Building, Wexham Road, Slough, SL2 5DS

**AkzoNobel**

<b><u>CONTENTS</u></b>	<b><u>Page</u></b>
1. <a href="#">SCOPE AND PURPOSE</a>	3
2. <a href="#">PRODUCT SPECIFICATION AND PRODUCT CURE GRAPHS</a>	4
2.1 <a href="#">Surface Preparation</a>	4
2.2 <a href="#">Specification</a>	4
2.3 <a href="#">Notes</a>	5
2.4 <a href="#">Holding Primer</a>	5
2.5 <a href="#">Product Cure Graphs</a>	5
3. <a href="#">COATING APPLICATION PROCEDURES</a>	7
4. <a href="#">TECHNICAL INSPECTION AND PROJECT CONTROL</a>	9
5. <a href="#">GENERAL NOTES</a>	10
5.1 <a href="#">Tank condition</a>	10
5.2 <a href="#">Steelwork Preparation</a>	11
5.3 <a href="#">Ventilation</a>	12
5.4 <a href="#">Dehumidification</a>	13
5.5 <a href="#">Heating</a>	13
5.6 <a href="#">Lighting</a>	13
5.7 <a href="#">Storage at point of application</a>	13
5.8 <a href="#">Grit Blasting</a>	14
5.9 <a href="#">Cleaning</a>	15
5.10 <a href="#">Paint Application</a>	16
5.11 <a href="#">Stripe Coats</a>	16
6. <a href="#">REPAIR PROCEDURES</a>	18
7. <a href="#">HEALTH &amp; SAFETY</a>	19

## Marine Coatings

All products supplied and technical advice or recommendations given are subject to our standard Conditions of Sale.

Registered in England No. 63604

Registered Office The AkzoNobel Building, Wexham Road, Slough, SL2 5DS

### 1. SCOPE AND PURPOSE

The International Paint Potable Water Tank Coatings Application Guidelines have been produced and revised in line with the Worldwide Marine product range. The purpose of the guidelines is to ensure that a coating system, as applied, provides adequate protection against corrosion such that potable water is not tainted.

Successful in-service performance of a tank coating system depends upon both the correct choice of coating and the adoption of the correct procedures for surface preparation and paint application.

The responsibilities for achieving the specific standards outlined and for carrying out surface preparation and paint application rest with the Contracting Company and Shipyard. Under no circumstances do these responsibilities rest with International Paint. We will generally provide for the presence of a Technical Service Representative at key stages during the performance of the contract. The role of the International Paint Technical Service Representative is advisory only unless otherwise specified in the terms and conditions of the contract.

## 2. PRODUCT SPECIFICATION AND PRODUCT CURE GRAPHS

### 2.1 SURFACE PREPARATION

#### 2.1.1 Surface Preparation

Grit blast entire tank to ISO Standard 8501-1 (2007) - Sa2½. A surface profile of between 50 and 100 microns is required.

#### 2.1.2 Application

Airless spray

### 2.2 SPECIFICATION

<u>Coat</u>	<u>Product</u>	<u>Colour</u>	<u>Dft (microns)</u>			<u>Dft (mils)</u>		
			Spec	Min	Max	Spec	Min	Max
Full	Interline 925	White	300	(265)	(600)	12	(10.43)	(24)
Stripe	Interline 925	Cream						
Stripe	Interline 925	White						

<u>Coat</u>	<u>Product</u>	<u>Colour</u>	<u>Dft (microns)</u>			<u>Dft (mils)</u>		
			Spec	Min	Max	Spec	Min	Max
Stripe	Interline 925	Cream						
Full	Interline 925	White	300	(265)	(600)	12	(10.43)	(24)
Stripe	Interline 925	White						

Note: Colours may be interchanged.

The minimum dft for the system is 265 microns (8.67 mils).

The maximum dft for the system is 600 microns (19.7 mils).

In way of areas of tanks that are difficult to paint due to their configuration, e.g. heavily stiffened tanks, and where a degree of overthickness is unavoidable, consult the International Paint Technical Service Representative for guidance.

### 2.3 NOTES

- 2.3.1 Refer to the accompanying graphs for recommended overcoating intervals, pot life and curing requirements.
- 2.3.2 The drying times quoted refer to a single coat applied to give 300 microns (12 mils) dry film thickness. At higher film thicknesses drying times may be extended, particularly at low temperature.
- 2.3.3 All thicknesses are to be checked by the International Paint Technical Service Representative on site. Any substandard areas are to be rectified.
- 2.3.4 For application the steel temperature must not be lower than 10°C (50°F) and should not exceed 40°C (104°F).
- 2.3.5 At ambient temperatures below 30°C (86°F) an in-line heater or hot twin feed unit is needed to assist application. Consult International Paint for detailed instructions.
- 2.3.6 Areas of overspray are to be sanded down prior to overcoating.
- 2.3.7 Humidity control is required during application of Interline 925. The climatic conditions within the tank must be controlled to maintain a maximum relative humidity of 50% at temperatures between 10-15°C (50-60°F), and a maximum relative humidity of 60% at temperatures of 16°C (61°F) and above.
- 2.3.8 Maximum overcoating intervals may need to be reduced when application takes place in conditions of poor ventilation. Consult International Paint.
- 2.3.9 Interline 925 is only WRAS approved when cured for 7 days at 15°C and only for use with water up to 60°C.

### 2.4 HOLDING-PRIMER

An optional coat of Intergard 269, applied at 40 microns (1.57 mils) dft, may be applied as a holding primer if required. Dry film thickness should not exceed 60 microns (2.36 mils) and addition of thinner may be necessary in order to achieve close control of film thickness. Consult your International Paint representative for thinner recommendations and over-coating intervals

### 2.5 PRODUCT CURE GRAPHS

- 2.4.1 Pot Life
- 2.4.2 Touch Dry Times
- 2.4.3 Hard Dry Times
- 2.4.4 Curing Time
- 2.4.5 Minimum Overcoating Intervals
- 2.4.6 Maximum Overcoating Intervals

# Application Guidelines

## Interline® 925

Revision 16 Date 2<sup>nd</sup> May 2017



**Interline 925: Pot Life**

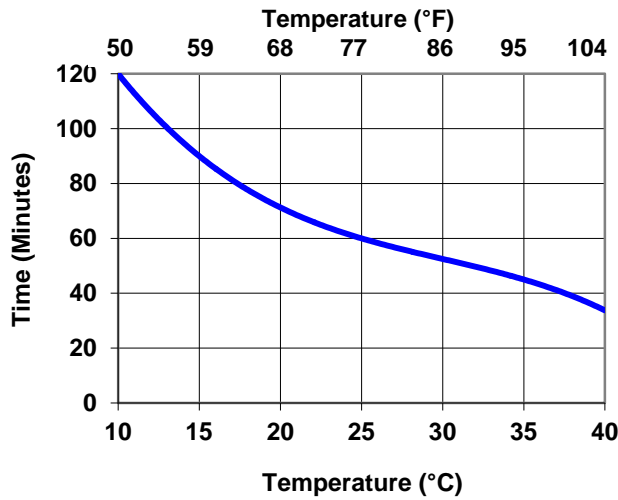

**Interline 925: Touch Dry**

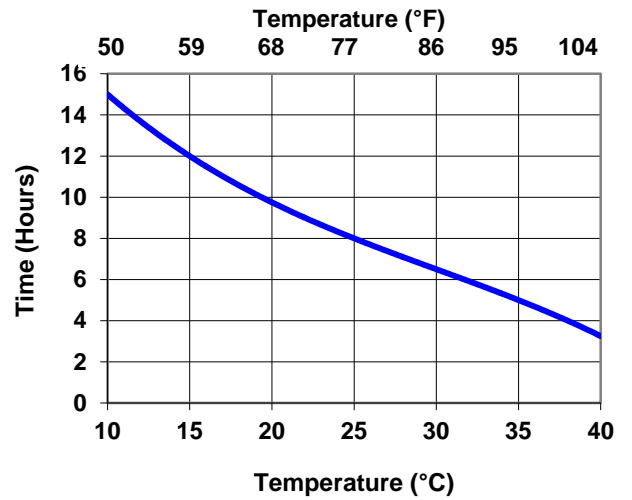

**Interline 925: Hard Dry**

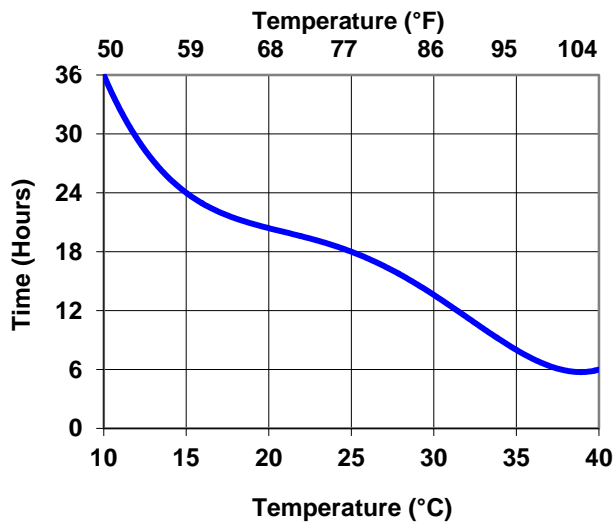

**Interline 925: Curing Time**

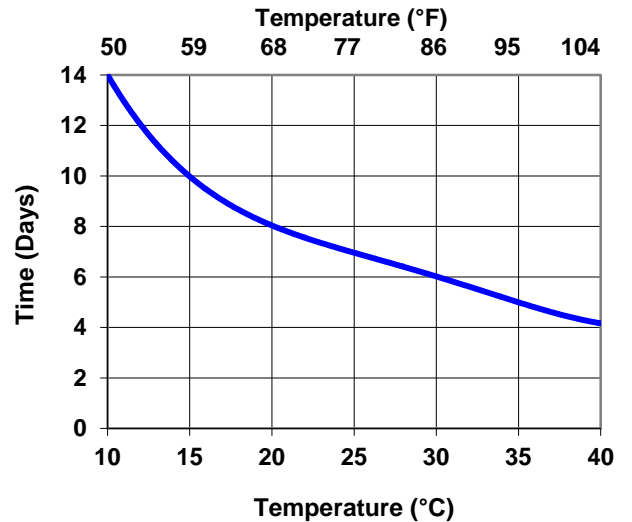

**Interline 925: Minimum Overcoating**

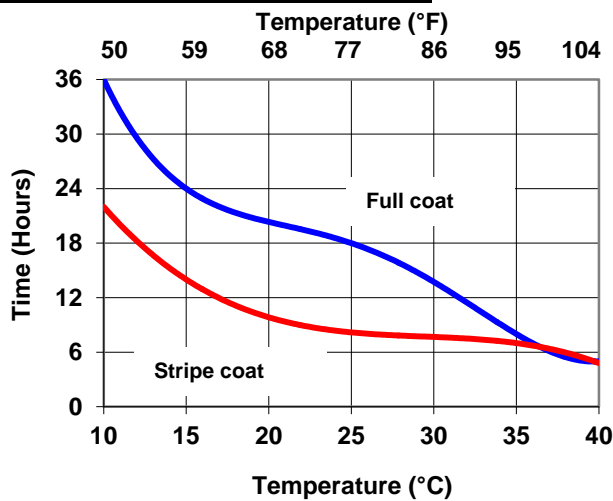

**Interline 925: Maximum Overcoating**

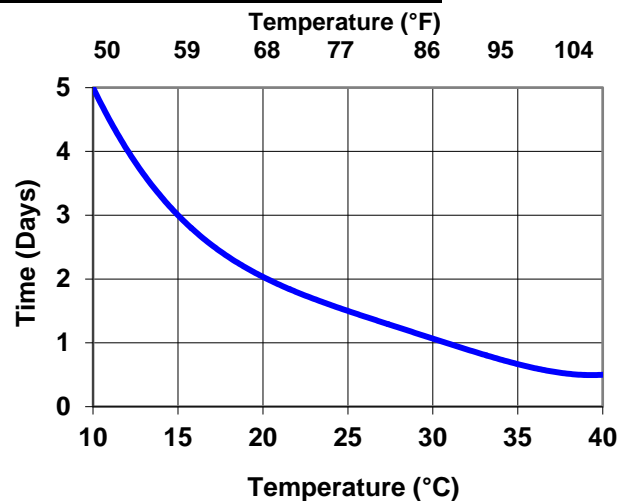

### Marine Coatings

All products supplied and technical advice or recommendations given are subject to our standard Conditions of Sale.

Registered in England No. 63604  
Registered Office The AkzoNobel Building, Wexham Road, Slough, SL2 5DS



### 3. COATING APPLICATION PROCEDURES

#### BLASTING COMPLETE TANK PRIOR TO ANY PAINTING

- 3.1 Grit blast the entire tank to ISO Standard ISO 8501-1 (2007) - Sa2½ - see Section 2.1.
- 3.2 Upon completion of the blasting, and after inspection by the Contractor Quality Control Department, the International Paint Technical Service Representative will also inspect the whole area and mark up any substandard areas.
- 3.3 All marked areas shall be re-blasted and brought up to the required standard. The whole blasted area is to be vacuum cleaned to remove dust and contamination.
- 3.4 Before coating of the blasted surfaces commences, the amount of residual salt should be measured using the Bresle patch method (ISO 8502-6: 2006 "Extraction of soluble contaminants for analysis – The Bresle method" / ISO 8502-9: 1998 "Field method for the conductimetric determination of water-soluble salts") or similar. These methods are also described in Module No.8 of the International Paint Technical Service training programme. If the result is less than 5 microgrammes/cm<sup>2</sup>, progress to 3.6. If the result is greater than 5 microgrammes/cm<sup>2</sup> progress to 3.5. The number of tests to be carried out is dependent upon tank size and a figure should be agreed before the contract begins. Contact International Paint.
- 3.5 The entire tank is to be fresh water washed. After the tank is dry, the salt contamination level is to be re-measured. The process outlined in 3.4 is to be repeated if the level is more than 5 microgrammes/cm<sup>2</sup>. The entire tank must then be re-blasted to ISO 8501-1 (2007) Sa2½. The specified surface profile given in Section 5.8.4 must be achieved. Salt levels should then be re-measured by following 3.4 above.
- 3.6 All the areas are to receive a full coat of Interline 925 to the specified dry film thickness, with minimum and maximum acceptable thicknesses as given in Section 2.2.
- 3.7 When hard dry, and accepted by the Contractor Quality Control Department, the International Paint Technical Service Representative will check the dry film thickness.
- 3.8 All areas itemised in Section 5.11 are to receive a stripe coat. The stripe coat should be applied within the overcoating intervals specified on the Interline 925 product data sheet.
- 3.9 All areas itemised in Section 5.11 are to receive a second stripe coat. The stripe coat should be applied within the overcoating intervals specified on the Interline 925 product data sheet.
- 3.10 The stripe coats are to be inspected by the International Paint Technical Service Representative.
- 3.11 If required, a second full coat of Interline 925 will be applied to the specified dry film thickness, with minimum and maximum acceptable thicknesses as given in Section 2.2.
- 3.12 When hard dry, and accepted by the Contractor Quality Control Department, the International Paint Technical Service Representative will check the dry film thickness.
- 3.13 Any areas of under thickness are to be brought up to the minimum thickness specified. This must be carried out within the overcoating intervals specified for the product.
- 3.14 All damages are to be either vacublasted or disced to the required standard. All damages are to be touched up with Interline 925 to the specified dry film thickness.

# Application Guidelines

## Interline® 925

Revision 16 Date 2<sup>nd</sup> May 2017



3.15 It is recommended that finished tanks be subjected to a water test to highlight pinholes/irregularities in the tank coating which have not been identified by normal visual inspection. This may be carried out either by:

- a) full ballasting of the tank for at least 24 hours.
- b) seawater re-circulation using the tank washing system for at least 48 hours. If freshwater is used the test duration must be doubled.

The minimum curing period prior to water testing is shown below:

Temperature °C	Temperature °F	Curing Days
10	50	14
15	59	10
20	68	8
25	77	7
30	86	6
35	95	5

Consult the International Paint Technical Service Representative for guidance.

3.16 Following testing, the tank should be dried and any defective area repaired in accordance with the recommendations of the International Paint Technical Service Representative. These recommendations will be based upon those outlined in Section 6.

3.17 Once all work is complete, fresh water flushing must be carried out. The tank should be filled with fresh water for a minimum of 24 hours, emptied, and then flushed with further fresh water.

## Marine Coatings

All products supplied and technical advice or recommendations given are subject to our standard Conditions of Sale.

Registered in England No. 63604

Registered Office The AkzoNobel Building, Wexham Road, Slough, SL2 5DS

**AkzoNobel**



### 4. TECHNICAL INSPECTION AND PROJECT CONTROL

Project control by regular inspection and agreement on future action is vital to successful tank coating projects, and in maximising the potential of a coating system.

All parties involved in the tank coating work must agree an inspection procedure prior to work commencing, this should outline how and when both work and inspection will be undertaken.

Prior to commencing the project the contractor(s) must be provided with copies of the relevant product data sheets. Attention should be drawn to pack sizes, mix ratios, thinning restrictions etc.

The International Paint Technical Service Representative must be present during initial mixing of the first drums of product to be applied to ensure that all parties are aware of mixing and application characteristics.

Daily meetings should be arranged to confirm performance of the work and inspection schedules. Minutes of these meetings must be taken and circulated to all participants. Representatives of the contractor, shipyard and ship owner would normally be present at these meetings.

In the event of work continuing at any stage without the approval of International Paint, the Company cannot be held responsible for any subsequent failure of the tank coating system on the areas concerned. Those areas **MUST** be specifically excluded from the performance guarantee. Such an event is termed an **EXCEPTION**. All parties **MUST** be officially informed in writing using the standard Exception Report Form immediately following the occurrence.

International Paint, and any other authorised personnel, may inspect any stage in the process. If additional inspections are considered necessary because of on site conditions or by agreement prior to commencement of the contract, then the contractor must obtain written approval for that stage from International Paint before continuing.

Contractors must supply interpreters if necessary.

On completion of the contract all relevant documentation must be retained, and safely archived, by the Local Technical Service Manager.

Inspection equipment for measurement of blast profile depth, relative humidity, wet and dry film thickness, etc. should be approved types and be correctly calibrated.

## **5. GENERAL NOTES**

### **5.1 TANK CONDITION**

#### **5.1.1 Newbuilding**

Prior to commencement of blasting it is essential that the tanks are clean, dry, and in a condition suitable for surface preparation and application of the tank coatings. The following briefly outlines the minimum requirements:

All grease and oil must be removed from all surfaces.

All hot work in way of tanks must be complete.

Cargo suction strums (if fitted) should be removed in order to give total access.

After final tank testing, tanks should be fresh water washed and dried, especially if they have been in contact with sea water.

Defective steelwork, prior to contract commencement, should be repaired in line with the guidance notes given in 5.2 (Steelwork Preparation).

#### **5.1.2 Major Refurbishment**

Prior to the commencement of blasting it is essential that the tanks are clean, dry, and in a condition suitable for surface preparation and application of tank coatings. The following briefly outlines the minimum requirements:

Tanks must be cleaned and gas free.

Any blisters present must be burst and blister caps removed from surface.

Heavy scale must be removed from all surfaces.

Scale, debris and cargo residues must be removed from the tanks.

All grease and oil must be removed from all surfaces.

All hot work in way of tanks must be complete.

Cargo suction strums (if fitted) should be removed in order to give total access.

All tanks must be fresh water washed.

Any areas of steel renewal should be prepared in the manner described in 5.2 Steelwork Preparation.

### 5.2 STEELWORK PREPARATION

Preparation grades of welds, cut edges and surface imperfections are described in ISO 8501-3. Preparation to P3 grade of this standard will provide surfaces which will ensure optimum paint performance. International Paint recommend the following methods and minimum levels of preparation on any new steelwork:

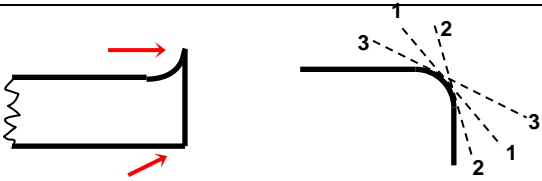
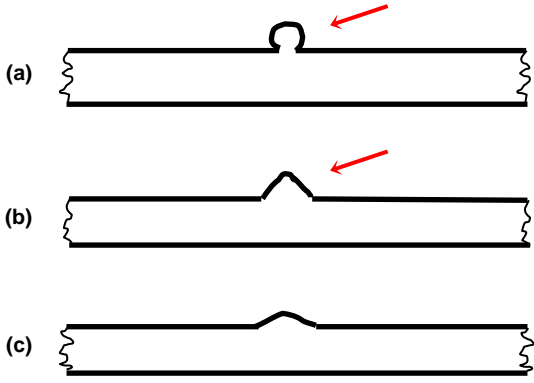
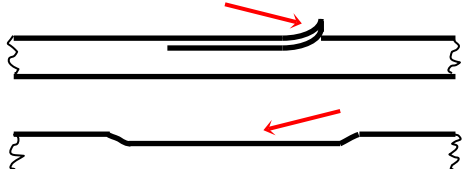
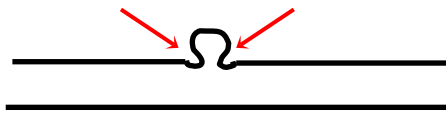
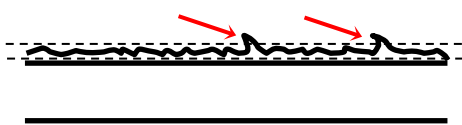
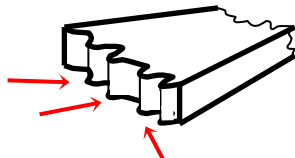
ITEM	PROBLEM / SOLUTION
Sharp Edge	<p>Edges should be treated to a rounded radius of minimum 2mm, or subjected to three pass grinding or equivalent.</p> 
Weld Spatter	<p>1. Remove spatter observed before blasting by grinder, chipping hammer etc.</p> <p>2. For spatter observed after blasting:</p> <ol style="list-style-type: none"> <li>Remove with chipping hammer /scraper etc.</li> <li>Where spatter is sharp, use disc sander or grinder until obtuse</li> <li>Obtuse spatter – no treatment required</li> </ol> 
Plate Lamination	<p>Any lamination to be removed by grinder or disc sander</p> 
Undercut	<p>Where undercut is to a depth exceeding 1mm and a width smaller than the depth, repair by welding or grinding may be necessary</p> 
Manual Weld	<p>For welding bead with surface irregularity or with excessive sharp edges, remove by disc sander or grinder</p> 
Gas Cut Surface	<p>For surfaces of excessive irregularity, remove by disc sander or grinder</p> 

### 5.3 VENTILATION

Ventilation is necessary during abrasive blasting operations to ensure adequate visibility. Flexible trunking should be used to allow the point of extraction to be reasonably close to the personnel carrying out the blasting.

During and after coating application the ventilation system and trunking must be so arranged such that “dead spaces” do not exist. As solvent vapours are heavier than air, and will tend to accumulate in the lower areas of tanks, it is important that they are extracted from those areas. This must be balanced with fresh air being introduced into the tank.

Equipment used must not re-introduce abrasive dust, solvent vapour etc. into the tank. For this reason a positive pressure, above normal atmospheric pressure, should be maintained inside the tank. As a “rule of thumb” fresh air supply/extraction should be in the approximate ratio of 4:3.

Ventilation must be maintained during application and continue whilst solvent is released from the paint film during drying. Failure to do this may result in solvent retention within the coating system that will adversely affect its long term performance. It must be maintained for a minimum period of 48 hours after coating application has been completed unless otherwise agreed with International Paint.

The level of ventilation employed must take account of the Lower Explosive Limit (LEL) of the product being applied and comply with local legislative requirements. (The LEL is the minimum concentration of vapour in air, expressed as a percentage, that will ignite). International Paint recommend that this is such that vapour concentrations do not exceed 10% of the LEL. This figure is in line with general industry standards and the requirements of the United Kingdom Health & Safety Executive (Information Document HSE 703/13 “Application of Surface Coatings to Ship’s Tanks”) and the United States Department of Labor Occupational Safety and Health Administration (OSHA) regulation 1915.36(a)(2).

The ventilation requirement can be calculated from the required air quantity (RAQ) to 10% of the LEL figures and the product application rate. A typical paint application rate by airless spray is 75-100 litres (19.7-26.3 U.S. Gallons) per hour per sprayer.

Venting to 10% of the LEL is considered to provide a reasonable margin of safety to allow for possible higher local concentrations due to the complex geometry of ballast tanks. Nevertheless, care should be taken when setting up ventilation/extraction systems, to ensure that 10% figure is not exceeded.

If the level of ventilation is reduced during coating application, in order to minimise possible dry spray, the paint application rate must also be reduced to ensure that solvent vapour levels remain below 10% of the LEL.

Responsibility rests with the shipyard/contractor to ensure that the requisite equipment is available and operated in such a way that these requirements are met. International Paint will provide all of the information needed to allow the shipyard/contractor to calculate ventilation requirements. However, International Paint does not accept responsibility for the equipment, its operation, or the monitoring necessary to ensure that the requisite ventilation requirements are met.

All equipment used after the commencement of paint application must be electrically safe in operation.

Provision must be made by the contractor/shipyard for continuous, round the clock, surveillance of ventilation equipment.

### 5.4 DEHUMIDIFICATION

Dehumidification equipment, when required, must be of adequate capacity to maintain the condition of blasted steelwork to the required standard. Additionally, in order to prevent condensation, the steel temperature must always be at least 3°C (5°F) above the dew point.

Coatings may only be applied to surfaces which have been maintained in a dry condition with the steel temperature at least 3°C (5°F) above the dew point for more than one hour. The surfaces must be visibly dry and clean at the time of application. This condition must be maintained until the coating is cured.

Tank Coating must only be undertaken under acceptable atmospheric conditions, otherwise adverse effects may occur. See section 2.3.7 for detailed relative humidity limitations.

Provision should be made for 24 hour surveillance of equipment.

### 5.5 HEATING

If heating is necessary to satisfy the painting specification, it should be by means of a heat exchange system, i.e. air admitted to the tank should not pass directly through a combustion chamber.

Temperatures should be maintained for the duration of the contract from application to cure and provision should be made for 24 hour surveillance of equipment by the contractor/shipyard.

### 5.6 LIGHTING

Lighting during painting must be electrically safe and provide suitable illumination for all work. As a guide, lighting may be considered suitable if this text can be read at a distance of 30 centimetres (12 inches) from the eye.

Ideally, the lighting should be powerful mains supplied spotlight with background lighting on at all times in the interests of safety.

Powerful mains spotlighting must be provided when inspection work is being carried out.

### 5.7 STORAGE (AT POINT OF APPLICATION)

The paint must be stored out of direct sunlight so that the temperature of the material will not exceed 35°C (95°F) for prolonged periods of time.

In winter months, when temperatures can be expected to fall below 5°C (41°F), base and curing agent must be stored in premises, (storeroom, hut, etc), which are heated to a temperature in excess of 5°C (41°F) for a period of not less than 48 hours immediately prior to use (unless stated otherwise on the product technical data sheet).

### 5.8 GRIT BLASTING

#### 5.8.1 General

Two main universal standards of surface preparation are normally specified for cargo tank coatings - ISO Standard ISO 8501-1 (2007) - Sa2½ and Sa3.

However, in general, the following comments apply to these standards.

Sa2½ - in practice, this is considered to be the best standard a skilled blasting operative can consistently achieve.

Sa3 - the possibility of achieving a uniform standard of Sa3 throughout the tanks is remote and a more realistic achievement would be somewhere between Sa2½ and Sa3.

#### Comparative Standards

<u>ISO 8501-1: 2007</u>	<u>Japanese Standard on new steel</u>	<u>SSPC Standard</u>
Sa2½	JA SH2	SSPC-SP10
Sa3	JA SH3	SSPC-SP5

Additionally, International Paint has identified acceptable limits of sweep blasting shop primers which may be specified after consultation with International Paint. These may be used with certain products and with certain shop primers, when carriage only of “white oils” is required.

Pictorial representations are available; see “Abrasive Sweep Standards - For Shop Primed Steel Surfaces (Edition 3)”

In cases where the substrate is corroded or pitted, it may be necessary to fresh water wash the areas after abrasive blasting, then re-blast, in order to ensure complete removal of soluble corrosion products.

#### 5.8.2 Compressed Air

Air used for blasting must be clean, oil free and dry. The pressure should be at least 7kg/cm<sup>2</sup> (100lb/sq inch) at the nozzle.

#### 5.8.3 Abrasive

Abrasives used for blasting must be dry and free from dirt, oil, grease and suitable for producing the standard of cleanliness and profile specified. The abrasive must therefore be in accordance with the specifications given in ISO 11126 - Parts 1 to 8 and each delivery should carry a certificate of conformity to this specification.

If blasting abrasive is supplied on site without a certificate of conformity, the material should be tested by the yard or contractor in accordance with the methods given in ISO 11127 - Parts 1 to 7.

Particular attention should be given to ISO 11127 - Part 6, where the level of water soluble contaminants must not give a conductivity value greater than 25mS/m, and ISO 11127 - Part 7, where the level of water soluble chlorides must not exceed 0.0025% by weight.

Iron or steel abrasives can be used for in-situ open blasting. Specifications for metallic abrasives are given in ISO 11124 - Parts 1 to 4 and the corresponding test methods in ISO 11125 - Parts 1 to 7. If used, careful and thorough cleaning must be carried out at all stages of the operation to ensure that no abrasive remains in the tank as this may subsequently corrode.

Although not recommended, recycled grit may be used providing it is dry, has been shown to be free from contamination by dirt, oil, grease, and has been tested in accordance with the above ISO standards.

### 5.8.4 **Blast Profile**

The required amplitude of the blast profile depends upon the type of coating to be applied. Measurement on site should be by profile gauge or other mutually acceptable instruments.

Measurement of surface profile using comparators is described in ISO 8503-2 using comparators detailed in ISO 8503-1. A blast profile of 55-95 microns is required and can be measured using:

- a) ISO 8503-3: Focusing microscope
- b) ISO 8503-4: Stylus

## 5.9 **CLEANING**

Prior to initial blasting inspection, the bulk of spent grit must be removed.

Any substandard areas should be identified and must be brought up to the specified standard.

All marking paint, chalk, etc, used to identify substandard areas must be removed after substandard areas are rectified. If marking pens are used, which cannot be removed, then they must be technically approved by the International Paint Worldwide Marine Laboratories prior to any overcoating taking place.

Following provisional approval of the blast standard, all remaining traces of grit and dust must be removed from all areas using industrial vacuum cleaners fitted with brushes, or by other suitable methods agreed by International Paint. The quantity of dust remaining should be no greater than Pictorial reference 1 : ISO 8502-3 and be of no greater size than Class 2 : ISO 8502-3.

Final approval of a substrate for coating application must be confirmed after final cleaning.

Mats for wiping feet, (or overshoes), should be placed at the entrance of tanks, and the area immediately surrounding them kept in a clean condition.

### 5.10 PAINT APPLICATION

All paints should be applied by airless spray except for stripe coats where brush or roller should in general be used.

Efficient mechanical stirrers for the correct mixing of paint must be used.

Available air pressure and capacity for spray equipment should be at least 5.5kg/cm<sup>2</sup> and 1.4m<sup>3</sup>/min (80 psi and 50 cfm).

All spray equipment must be in good working order and be capable of performing to the output requirements defined in International Paint product technical data sheets.

It is recommended that airless spray pump ratios of 60:1 or greater should be used. At ambient temperatures below 30°C (86°F) an in-line heater or hot twin feed unit is required to assist application.

Tips should be the size stipulated on the product technical data sheet, or as agreed with the International Paint representative on site. Tips must not be in a worn condition.

Both during and following application of paint, all operatives entering the confines of coated tanks must wear soft-soled shoes or overshoes.

### 5.11 STRIPE COATS

Stripe coating is an essential part of good painting practice. Typical areas where stripe coats must be applied include:

- behind bars
- plate edges
- cut outs i.e. scallops, manholes etc
- welds
- areas of difficult access
- ladders and handrails
- small fitments of difficult configuration
- areas of pitting

Note: The above list is not comprehensive, all areas must be included. The diagrams following indicate key areas requiring stripe coating:

In general, stripe coats should be applied by brush or roller, depending upon items concerned.

In exceptional circumstances it may be acceptable to apply a stripe coat to the backs of angle bars by narrow angle spray. The use of spray applied stripe coats however, must be discussed and agreed with the International Paint representative on site.



# Application Guidelines

## Interline® 925

Revision 16 Date 2<sup>nd</sup> May 2017

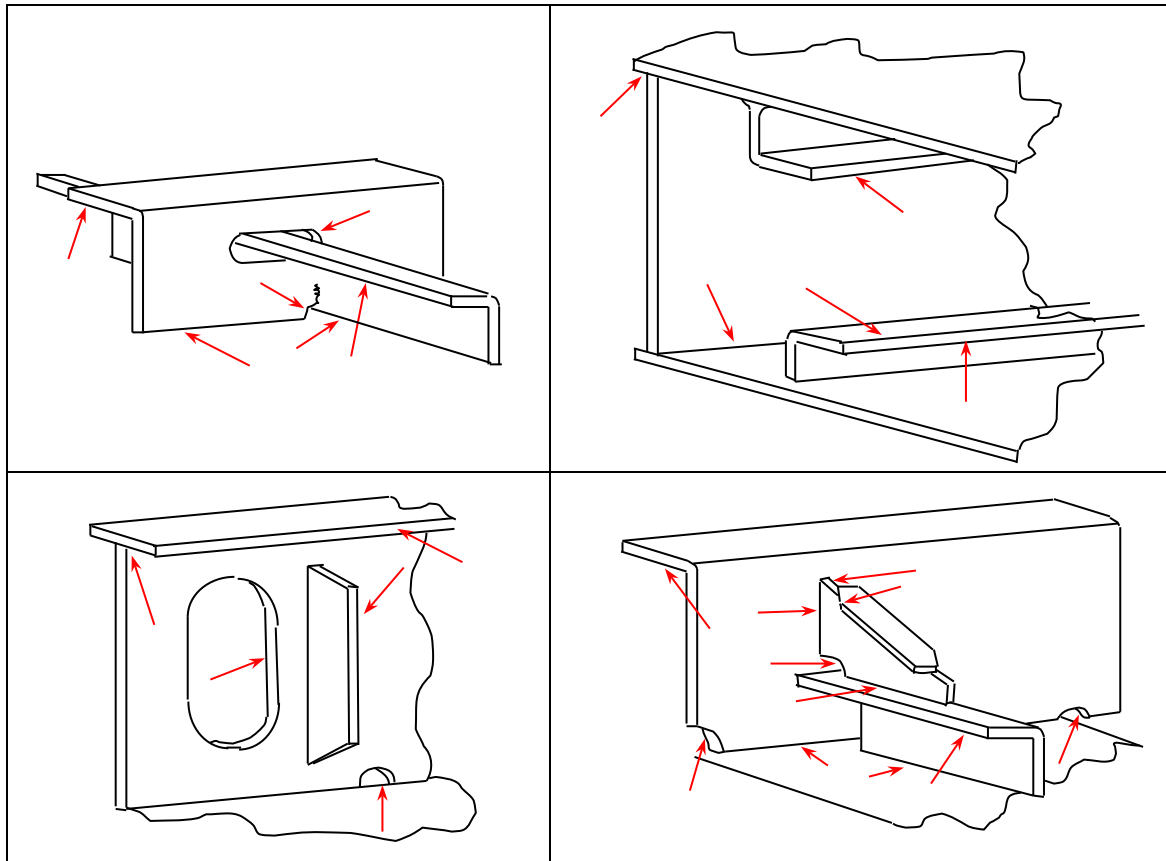

### Marine Coatings

All products supplied and technical advice or recommendations given are subject to our standard Conditions of Sale.

Registered in England No. 63604  
Registered Office The AkzoNobel Building, Wexham Road, Slough, SL2 5DS



## **6. REPAIR PROCEDURES**

### **6.1 INTRODUCTION**

These repair procedures are recommended for damages either at the initial coating stage or where breakdown of coating has occurred during the service life of the vessel.

The repair procedure recommended will depend upon the extent of damage involved but can be split into:

- i) Repairs of major areas
- ii) Repairs of minor areas

### **6.2 MAJOR REPAIRS**

A Major repair should essentially be dealt with as if the project were beginning. The recommendations given earlier for steel preparation, coating application, etc. MUST all be adhered to.

### **6.3 MINOR REPAIRS**

Under this heading are repairs to areas damaged either at the initial coating stage, i.e. caused by de-staging, etc or caused during service, i.e. tank cleaning equipment damages, spot corrosion, etc. The principle requirements are:

The area to be repaired must be fresh water washed and dry.

Remove any corrosion by means of either:

- vacuum blasting
- hand tools, i.e. disc sander and grinder.

Any pittings which, in the opinion of the Classification Society, do not need re-welding, should be prepared by needle gun and/or cone shaped grinder to remove corrosion deposits.

It is not normally recommended to use filler in pittings as it is likely to detach, taking with it any paint which has subsequently been applied, thus exposing the steelwork to possible further corrosion.

If however, it is decided to use filler, it must be applied after the first coat of the system, then overcoated with the remaining coats.

Abrade area immediately surrounding repair to provide key for subsequent paint application.

Apply the paint system in accordance with our recommendations. If small areas are involved and application is by brush, several coats may be required to achieve the correct dry film thickness.

Cure time - when minor repairs have been carried out the cure time can be reduced to 75% of that recommended for full tank applications.

## 7. HEALTH & SAFETY

### 7.1 INTRODUCTION

Some tank coatings contain volatile flammable organic solvents which can form explosive mixtures with air. Definite safety precautions must be taken whilst applying this type of coating in the confines of a ship's ballast tank. Detailed attention must be given to the following points:

- Danger of explosion or fire.
- Provision of a suitable breathing environment for workers.
- Prevention of skin irritation problems.
- Use of paints which have been specially formulated for use in ballast tanks.

### 7.2 DANGER OF EXPLOSION OR FIRE

The key factors in preventing an explosion or fire are:

- Adequate ventilation.
- Elimination of naked flames, sparks and any ignition sources.

Any organic solvent based coating could, merely by the normal process of drying, give off sufficient solvent vapour to produce an explosive mixture in a tank when the vapour concentration reaches or exceeds 1% by volume in air. However, at 1% the solvents in the coatings produce an unpleasant odour, (often with irritating skin effects) and smarting of the eyes. These symptoms must be taken as a warning sign that better ventilation is needed. 0.1% solvent vapour in air is normally recommended to give a tenfold safety margin and at this concentration, no explosion can occur and no operator effects should be noticed.

Sampling apparatus to detect the exact concentration of solvents should be used at regular intervals, particularly in "dead spots" where locally high concentrations may occur.

### 7.3 VENTILATION

(Note: This must be read in conjunction with General Note 5.3).

Ventilation is necessary during abrasive blasting operations to ensure adequate visibility. Flexible trunking should be used to allow the point of extraction to be reasonably close to the personnel carrying out the blasting.

During and after coating application it is essential that solvent vapours are removed to ensure that the level present in the atmosphere does not rise above that recommended in the section (7.2) dealing with "Danger of Explosion and Fire". This means that the ventilation system must be arranged such that "dead spaces" do not exist and the ventilation must be continued both during the time that application is proceeding and also whilst solvent is released from the paint film during the drying process. Particular care must be taken to ensure that solvent vapour, which is heavier than air, does not accumulate in the lower areas of the tanks.

The amount of air per minute for ventilating to 10% of the LEL (lower explosive limit) can be regarded as the required air quantity multiplied by rate of application per minute. The required air quantity is the amount of air needed for each litre of paint to ventilate to the required level.

RAQ = Required Air Quantity  
LEL = Low Explosive Limit

Ventilation required (m<sup>3</sup>/minute) = RAQ x the application rate (litres/minute). The likely approximate application rate can be calculated from figures available from the application equipment supplier and will depend on the airless spray pump pressure and the orifice size of the tip used.

The geometry and size of tanks makes each one a separate problem, and it is essential that the ventilation arrangement, fan type, etc is checked as being suitable before painting commences.

Fore and aft peaks and double bottoms require special attention. Because of their construction, adequate ventilation is difficult and rapid build-up of solvent vapour and explosive concentrations may occur. It is recommended that, when workers are involved in such spaces, a careful check is kept that men are not in difficulty and that there is supervised continuity of essential services such as air and electricity.

In the event of a failure of the extraction/ventilation system paint application must be stopped and the tanks evacuated of personnel immediately.

### 7.4 **ELIMINATION OF IGNITION SOURCES**

Safety is the overriding consideration with this type of tank coating work, and the Contractor and Crew must be made fully aware of all aspects of the operation.

Welding, cutting or grinding in the tank must be forbidden until paint fumes are totally ventilated. This also applies to all areas within a 20m (60 feet) radius of tank and trunking outlets.

Coamings and hatch openings must be covered so as to efficiently prevent spark entry where welding is being carried out on the superstructure.

Lights, including hand torches, must be certified by the manufacturer as flash proof and suitable for use in solvent laden atmospheres.

Smoking must be prohibited in or near tanks or extraction systems.

No electrical junction boxes should be allowed in tanks.

Airless spray equipment must be earthed (because of the danger of static electricity build-up)

Mobile telephones, electrical cameras, and any equipment that is not intrinsically safe, must not be used in or near tanks or extraction systems until paint fumes are totally dispersed.

### 7.5 **SOLVENT VAPOUR AND PAINT MISTS - PROTECTION OF PAINTING PERSONNEL**

No ventilation system can reduce solvent vapour levels to below the Occupational Exposure Limit for solvents whilst tank coating is in operation. Painters must, therefore, wear air fed hoods or pressure fed masks with additional eye protection. (Please note: air fed hoods which provide a curtain of air across the visor are available. These help to prevent settlement of spray mist on the visor). Normal protective clothing must be worn, e.g. overalls, gloves, and suitable footwear of non-spark type.

### 7.6 SKIN IRRITATION

If proper protective clothing has been worn, e.g. overalls, gloves, air fed hood, etc no discomfort should be experienced from skin irritation. Any small areas not protected by clothing, e.g. wrists or neck, can be treated with a non-greasy barrier cream. (Petroleum jelly is not recommended as this can assist the transport of solvents into the skin).

Any areas of skin accidentally contaminated with paint must be thoroughly washed with soap and water. A skin conditioner that is designed to replace the natural oils in the skin can be used.

#### Note

1. The preceding safety information is given for guidance only.
2. It is imperative that, prior to the commencement of any tank coating project, local Regulations regarding Health and Safety be consulted.

*All representations and statements concerning the product(s) in this publication are accurate to the best of our knowledge. Statements made in this publication are advisory only and are not intended to be specific recommendations or warranties of any product, combination of products or fitness for any particular purpose. To the extent permitted by law, we do not accept any liability to any person for any loss or damage (direct or indirect) that may arise from any use or reliance on any of the methods or information contained in this publication for any purpose.*

*Unless otherwise agreed in writing, all products supplied and technical advice or recommendations given are subject to the Conditions of Sale of our supplying company. Any warranties, if given, are contained in those standard Conditions of Sale and are the only ones made with respect to any products we sell to your or advice or recommendations we give to you.*

*We hereby disclaim any warranties or representations, expressed or implied, by operation of law or otherwise, including, without limitation, any implied warranty of merchantability or fitness for a particular purpose.*

*For each of our products the relevant Product Data Sheet, Material Safety Data Sheet and package labelling comprise an integral information system about the product in question. Copies of our Product Data Sheets and Material Safety Data Sheets are available on request or from our website: [www.international-marine.com](http://www.international-marine.com).*

 and all product names mentioned in this publication are trademarks of, or licensed to, Akzo Nobel.

## Marine Coatings

All products supplied and technical advice or recommendations given are subject to our standard Conditions of Sale.

Registered in England No. 63604

Registered Office The AkzoNobel Building, Wexham Road, Slough, SL2 5DS

