

APPLICATION GUIDELINES

BALLAST TANKS

Interline® 783

Revision 7

Issue Date: 1st May 2015

Marine Coatings

All products supplied and technical advice or recommendations given are subject to our standard Conditions of Sale.

Registered in England No. 63604

Registered Office 26th Floor, Portland House, Bressenden Place, London SW1E 5BG

AkzoNobel

<u>CONTENTS</u>	<u>Page</u>
1. SCOPE AND PURPOSE	3
2. PRODUCT SPECIFICATION AND PRODUCT CURE GRAPHS	4
2.1 Surface Preparation	4
2.2 Specification	4
2.3 Film Thickness	5
2.4 Holding Primer	5
2.5 Notes	5
2.6 Product Cure Graphs	6
3. COATING APPLICATION PROCEDURES	8
4. TECHNICAL INSPECTION AND PROJECT CONTROL	11
5. GENERAL NOTES	12
5.1 Tank condition	12
5.2 Steelwork Preparation	13
5.3 Scaffolding	14
5.4 Ventilation	14
5.5 Dehumidification	15
5.6 Heating	15
5.7 Lighting	16
5.8 Storage at point of application	16
5.9 Grit Blasting	16
5.10 Cleaning	18
5.11 Paint Application	18
5.12 Stripe Coats	20
5.13 Adhesion Testing	21
6. REPAIR PROCEDURES	23
7. HEALTH & SAFETY	24

1. SCOPE AND PURPOSE

The International Paint Ballast Tank Coating Application Guidelines are produced and revised in accordance with the Worldwide Marine product range. The purpose of the guidelines is to ensure that a coating system, when correctly applied, provides the necessary protection against corrosion.

Successful in-service performance of a ballast tank coating system depends upon both the correct choice of coating and the adoption of the correct procedures for surface preparation and paint application.

This document provides guidance to the specialised field of ballast tank coating application. It is the result of experience gained by International Paint during the application of sophisticated ballast tank coatings to over 10,100 vessels since 1960.

The responsibilities for achieving the specific standards outlined and for carrying out surface preparation and paint application rest with the Contracting Company and Shipyard. Under no circumstances do these responsibilities rest with International Paint. We will generally provide for the presence of a Technical Service Representative at key stages during the performance of the contract. The role of the International Paint Technical Service Representative is advisory only, unless otherwise specified in the terms and conditions of the contract.

2. PRODUCT SPECIFICATION AND PRODUCT CURE GRAPHS

Interline 783 has been approved to satisfy the requirement for:

- **Low Temperature Cure**
Interline 783 will cure down to temperatures of 32°F (0°C)
- **Fast Cure**
Interline 783 will give fast return to service at temperatures of 77°F (25°C)

2.1 SURFACE PREPARATION

2.1.1 Surface Preparation

Clean welds and damaged or corroded shop primer by blasting to "Near White Blast Cleaning" (SSPC-SP10). A sharp, angular surface profile of 2.0-4.0 mils (50-100 microns) is recommended.

2.1.2 Application

Plural Feed Airless spray

2.2 SPECIFICATION

	<u>Coat</u>	<u>Product</u>	<u>Colour</u>	<u>DFT (mils)</u>	<u>DFT (microns)</u>
(i)	Full	THA787/785	Pink	6	150
	Stripe ⁽¹⁾⁽²⁾	THA783/785	Grey		
	Full	THA782/785	Buff	14	350
or					
(ii)	Full	THA782/785	Buff	20	500
	Stripe ⁽¹⁾⁽²⁾	THA783/785	Grey		
or					
(iii)	Full	THA782/785	Buff	10	250
	Stripe ⁽¹⁾⁽²⁾	THA783/785	Grey		
	Full	THA783/785	Grey	10	250

Specification notes:

- (1) Application of the stripe coat is by plural feed airless spray, utilising small tips and controlled application techniques.
- (2) Due to the short pot-life of Interline 783, it is difficult to apply stripe coats by brush or roller. For this reason, Interline 783 stripe coats is recommended to be applied using plural feed airless spray, with a narrow fan angle tip. In some difficult to reach areas (e.g. scallops), application by airless spray may not be possible. In these circumstances, other application methods, such as by brush, will be necessary – please consult the International Paint representative for additional information.
- Other paints may be used for stripe coating, please consult the International Paint representative for additional information.

Refer to Appropriate NAVSEA Preservation Process Instruction (PPI) and ASTM F-718 Data Sheet where necessary.

Please consult with your local International Paint Representative for a current listing of Interline 783 QPL Approvals.

2.3 **FILM THICKNESS**

Maximum Film Thickness

When a ballast tank is presented for final dry film thickness inspection, the film thickness distribution will be positively skewed. The majority of readings will vary from the minimum up to 250% of the specified d.f.t. However, in way of areas of tanks that are difficult to paint due to their configuration, e.g. heavily stiffened, and where a degree of significant overthickness is unavoidable, dry film thickness readings up to 50 mils dft can be expected.

Minimum Film Thickness

The specified d.f.t. must be achieved on 90% of the total coated surface area. A minimum d.f.t., equivalent to 90% of that specified, must be achieved on the remaining 10%.

For further information, consult International Paint.

2.4 **HOLDING-PRIMER**

Not recommended. In exceptional circumstances consult your International Paint Technical Service Representative for guidance.

2.5 **NOTES**

- 2.5.1 Refer to the accompanying graphs for recommended overcoating intervals and curing requirements.
- 2.5.2 The drying times quoted refer to a single coat of THA782/5 or THA787/5 applied at 10 mils dry film thickness. At higher film thicknesses drying times may be extended, particularly at low temperatures.
- 2.5.3 Touch up of damages caused during destaging is to be done by plural feed airless spray with self to a minimum dry film thickness of 14 mils.
- 2.5.4 All thicknesses are to be checked by the International Paint Technical Service Representative on site. Any substandard areas are to be rectified.
- 2.5.5 For application the steel temperature must not be lower than 32°F (0°C) and should not exceed 122°F (50°C).
- 2.5.6 Areas of overspray are to be sanded down and cleaned in accordance with SSPC-SP1 and SSPC-SP2 standards and remove all contaminants prior to overcoating.

2.6 PRODUCT CURE GRAPHS

- 2.6.1 Touch Dry Times
- 2.6.2 Hard Dry Times
- 2.6.3 Times to Ballast
- 2.6.4 Minimum Overcoating Intervals (full coat and stripe coat)
- 2.6.5 Maximum Overcoating Intervals (full coat and stripe coat)

Interline 783: Touch Dry

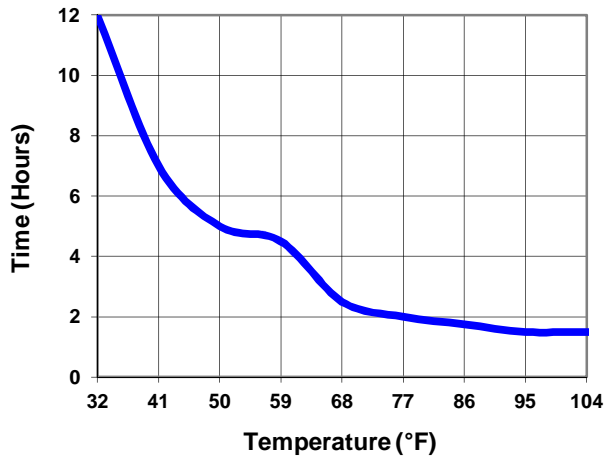

Interline 783: Hard Dry

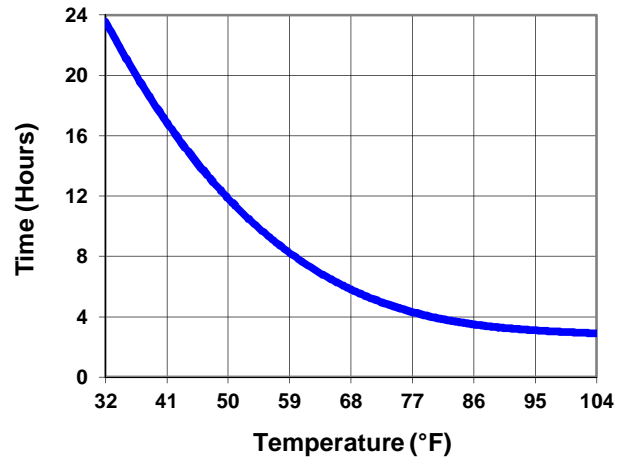

Interline 783: Time to Ballast

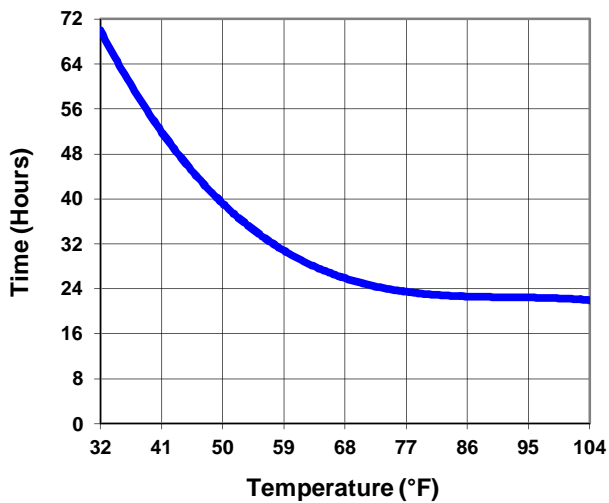

Interline 783: Minimum Overcoating

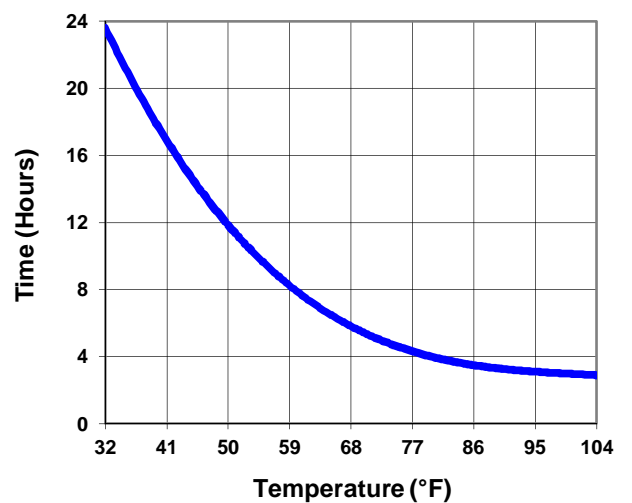

Application Guidelines Interline® 783

Revision 7 Date 10th April 2015



Interline 783: Maximum Overcoating (with UV)

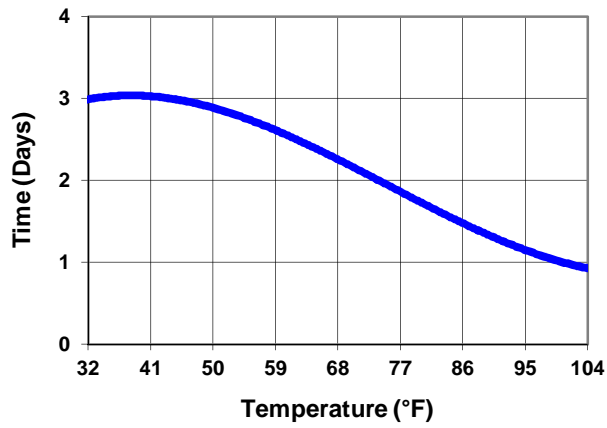

Interline 783: Maximum Overcoating (without UV)

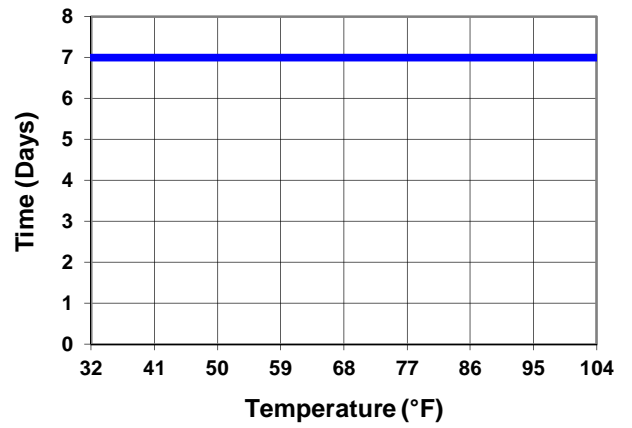

Marine Coatings

All products supplied and technical advice or recommendations given are subject to our standard Conditions of Sale.

Registered in England No. 63604
Registered Office 26th Floor, Portland House, Bressenden Place, London SW1E 5BG



3. COATING APPLICATION PROCEDURES

3.1 FOR IN-SITU APPLICATIONS

- 3.1.1 Remove weld spatter and grind sharp edges and uneven welds until smooth.
- 3.1.2 Grit blast welds, damage, shop primer and areas of corrosion to SSPC-SP10 "Near White Blast Cleaning" standard, to SSPC-SP11 "Power Tool Cleaning to Bare Metal" standard.
- 3.1.3 Upon completion of the blasting, and after inspection by the Contractor Quality Control Department, the International Paint Technical Service Representative will also inspect the whole area and mark up any substandard areas.
- 3.1.4 All marked areas shall be brought up to the specified standard of preparation. The whole blasted area is to be vacuum cleaned to remove dust and contamination.
- 3.1.5 If measurement of salt contamination is to be carried out, see section 3.3 of this procedure.
- 3.1.6 Apply the coating scheme as specified in section 2.2 of this procedure. Observe the specified, maximum and minimum dry film thickness.

Stripe coats should be applied to areas itemised in section 5.12 of this procedure.

When hard dry, each full coat and each stripe coat is to be inspected by the International Paint Technical Service Representative.

Prior to application of subsequent coats, ensure surfaces are clean and dry after stripe coating and inspection procedures.
- 3.1.7 Once the full system has been applied, and has been accepted by the Contractor Quality Control Department, the International Paint Technical Service Representative will check the dry film thickness.
- 3.1.8 Any areas of under thickness are to be brought up to the minimum thickness specified.

3.2 FOR APPLICATIONS AT BLOCK STAGE

At Block Stage

- 3.2.1 Remove weld spatter and grind sharp edges and uneven welds until smooth.
- 3.2.2 Grit blast welds, damage, shop primer and areas of corrosion to SSPC-SP10 "Near White Blast Cleaning" standard, to SSPC-SP11 "Power Tool Cleaning to Bare Metal" standard.
- 3.2.3 Upon completion of the blasting, and after inspection by the Contractor Quality Control Department, the International Paint Technical Service Representative will also inspect the whole area and mark up any substandard areas.
- 3.2.4 All marked areas shall be brought up to the specified standard of preparation. The whole blasted area is to be vacuum cleaned to remove dust and contamination.
- 3.2.5 If measurement of salt contamination is to be carried out, see section 3.3 of procedure.
- 3.2.6 Apply the coating scheme as specified in section 2.2 of this procedure. Observe the specified, maximum and minimum dry film thickness. Leave a 6 inch gap from the plate edge.

Stripe coats should be applied to areas itemised in section 5.12 of this procedure.

When hard dry, each full coat and each stripe coat is to be inspected by the International Paint Technical Service Representative.

Prior to application of subsequent coats, ensure surfaces are clean and dry after stripe coating and inspection procedures.

3.2.7 Once the full system has been applied, and has been accepted by the Contractor Quality Control Department, the International Paint Technical Service Representative will check the dry film thickness.

3.2.8 Any areas of under thickness are to be brought up to the minimum thickness specified.

After Erection

3.2.9 Ensure the surfaces to be painted are clean, dry and free of all contamination.

3.2.10 Prepare join-up areas, areas of damage and corrosion to the specified standard.

3.2.11 Lightly disc / abrade 6 inches of the edge of the existing coating applied at block stage to provide a key for overcoating on overlap areas.

3.2.12 Ensure surfaces are clean and free from debris.

3.2.13 To these areas, apply the coating scheme as specified in section 2.2 of this procedure. Observe the specified, maximum and minimum dry film thickness.

Stripe coats should be applied to areas itemised in section 5.12 of this procedure.

When hard dry, each full coat and each stripe coat is to be inspected by the International Paint Technical Service Representative.

Prior to application of subsequent coats, ensure surfaces are clean and dry after stripe coating and inspection procedures.

3.2.14 Once the full system has been applied, and has been accepted by the Contractor Quality Control Department, the International Paint Technical Service Representative will check the dry film thickness.

3.2.15 Any areas of under thickness are to be brought up to the minimum thickness specified. This must be carried out within the overcoating limits specified for the product.

3.3 MEASUREMENT OF SALT CONTAMINATION PRIOR TO COATING

The procedure below can be used in conjunction with the above application procedures.

- 3.3.1 Prior to coating the prepared (e.g. gritblasted) surface, measure the amount of residual salt using the Bresle patch method (ISO 8502-6: 2006) or similar. The number of tests to be carried out will depend upon the size of the area and should be agreed before the contract begins.
- 3.3.2 If the result is less than 10 microgrammes/cm² painting can proceed.
- 3.3.3 If the result is greater than 10 microgrammes/cm², the area should be fresh water washed and, when dry, the salt contamination level re-measured.
- 3.3.4 This washing process is to be repeated if the level is again greater than 10 microgrammes/cm².
- 3.3.5 The entire area should then be re-blasted to "Near White Blast Cleaning" (SSPC-SP10) and the salt contamination measurement process (2.3) repeated.

4. TECHNICAL INSPECTION AND PROJECT CONTROL

Project control by regular inspection and agreement on future action is vital to successful tank coating projects, and in maximising the potential of a coating system.

All parties involved in the ballast tank coating work must agree an inspection procedure prior to work commencing, this should outline how and when both work and inspection will be undertaken.

Prior to commencing the project the contractor(s) must be provided with copies of the relevant product data sheets. Attention should be drawn to pack sizes, mix ratios, thinning restrictions etc.

A series of standard forms are used by International Paint to monitor all tank and ballast coating projects.

Daily meetings should be arranged to confirm performance of the work and inspection schedules, minutes of these meetings must be taken and circulated to all participants. Representatives of the contractor, shipyard and ship owner would normally be present at these meetings for major refurbishment applications.

At major refurbishment, and if International Paint are present during On Board maintenance application, in the event of work continuing at any stage without the approval of International Paint, the Company cannot be held responsible for any subsequent failure of the tank coating system on the areas concerned. Those areas **MUST** be specifically excluded from the performance guarantee. Such an event is termed an **EXCEPTION**. All parties **MUST** be officially informed in writing using the standard Exception Report Form immediately following the occurrence.

International Paint, and any other authorised personnel, may inspect any stage in the process. If additional inspections are considered necessary because of on site conditions or by agreement prior to commencement of the contract, then the contractor must obtain written approval for that stage from International Paint (if present) before continuing.

Contractors must supply interpreters if necessary.

On completion of the contract all relevant documentation must be retained, and safely archived, by the Contractor and the International Paint Technical Service Representative (if present).

Inspection equipment for measurement of profile depth, humidity, wet and dry film thickness, etc should be of approved types and should be within calibration limits.

NOTE: When measuring the dry film thickness of coatings, the d.f.t. gauge must be calibrated prior to use as follows:

1. Check that the probe is clean.
2. Place the probe on a sample of millscale-free **smooth** steel of thickness greater than 1mm.
3. Calibrate the instrument to zero.
4. Select a certified shim of similar thickness to that expected for the coating under test.
5. Calibrate the gauge to the shim thickness.
6. Check that the gauge reads zero when replaced on the smooth steel sample.

Measurement of dry film thickness is described in ISO Standard 2808:2007.

5. GENERAL NOTES

5.1 TANK CONDITION

5.1.1 Newbuilding

Prior to commencement of blasting it is essential that the tanks are clean, dry, and in a condition suitable for surface preparation and application of the tank coatings. The following briefly outlines the minimum requirements:

All grease and oil must be removed from all surfaces.

All hot work in way of tanks should be complete.

After final tank testing, tanks should be fresh water washed and dried, especially if they have been in contact with sea water.

Defective steelwork, prior to contract commencement, should be repaired in line with the guidance notes given in 5.2 (Steelwork Preparation).

5.1.2 Major Refurbishment

Prior to the commencement of blasting it is essential that the tanks are clean, dry, and in a condition suitable for surface preparation and application of tank coatings. The following briefly outlines the minimum requirements:

- Tanks must be cleaned and gas free.
- Any blisters present must be burst and blister caps removed from surface.
- Heavy scale must be removed from all surfaces.
- Scale, debris and cargo residues must be removed from the tanks.
- All grease and oil must be removed from all surfaces.
- All hot work in way of tanks must be complete.
- Cargo suction strums (if fitted) should be removed in order to give total access.
- All tanks must be fresh water washed.
- Any areas of steel renewal should be prepared in the manner described in 5.2 Steelwork Preparation.

5.2 STEELWORK PREPARATION

Preparation grades of welds, cut edges and surface imperfections are described in ISO 8501-3. Preparation to P3 grade of this standard will provide surfaces which will ensure optimum paint performance. International Paint recommend the following methods and minimum levels of preparation on any new steelwork:

ITEM	PROBLEM / SOLUTION
Sharp Edge	<p>Edges should be treated to a rounded radius of minimum 2mm, or subjected to three pass grinding or equivalent.</p>
Weld Spatter	<p>1. Remove spatter observed before blasting by grinder, chipping hammer etc.</p> <p>2. For spatter observed after blasting:</p> <ol style="list-style-type: none"> Remove with chipping hammer /scraper etc. Where spatter is sharp, use disc sander or grinder until obtuse Obtuse spatter – no treatment required
Plate Lamination	<p>Any lamination to be removed by grinder or disc sander</p>
Undercut	<p>Where undercut is to a depth exceeding 1mm and a width smaller than the depth, repair by welding or grinding may be necessary</p>
Manual Weld	<p>For welding bead with surface irregularity or with excessive sharp edges, remove by disc sander or grinder</p>
Gas Cut Surface	<p>For surfaces of excessive irregularity, remove by disc sander or grinder</p>

5.3 SCAFFOLDING

Tubular scaffolding must not mask surfaces to be coated. Where contact is necessary then spade ends should be used.

Staging should afford easy and safe access to all surfaces to be coated and should be between 15cm and 30cm (6 and 12 inches) from vertical surfaces which are to be coated.

Tubular scaffolding must be plugged or capped prior to grit blasting to prevent the ingress of grit and dirt.

Staging should be designed to allow thorough cleaning. Where scaffolding is wooden, International Paint recommend that staging be of the 'turn over' type, when local safety regulations permit.

Distance between staging levels should not exceed two metres (6 feet).

If fixed staging lugs are fitted, these should be stainless steel.

Staging layout should be such that ventilation is not rendered ineffective.

Care must be taken when removing scaffolding in order to keep damages to a minimum. Any damages must be repaired in accordance with the recommendations of the International Paint representative on site.

5.4 VENTILATION

Ventilation is necessary during abrasive blasting operations to ensure adequate visibility. Flexible trunking should be used to allow the point of extraction to be reasonably close to the personnel carrying out the blasting.

During and after coating application the ventilation system and trunking must be so arranged such that "dead spaces" do not exist. As solvent vapours are heavier than air, and will tend to accumulate in the lower areas of tanks, it is important that they are extracted from those areas. This must be balanced with fresh air being introduced into the tank.

Equipment used must not re-introduce abrasive dust, solvent vapour etc. into the tank. For this reason a positive pressure, above normal atmospheric pressure, should be maintained inside the tank. As a "rule of thumb" fresh air supply/extraction should be in the approximate ratio of 4:3.

Ventilation must be maintained during application and continue whilst solvent is released from the paint film during drying. Failure to do this may result in solvent retention within the coating system that will adversely affect its long term performance. It must be maintained for a minimum period of 48 hours after coating application has been completed unless otherwise agreed with International Paint.

The level of ventilation employed must take account of the Lower Explosive Limit (LEL) of the product being applied and comply with local legislative requirements. (The LEL is the minimum concentration of vapour in air, expressed as a percentage, that will ignite). International Paint recommend that this is such that vapour concentrations do not exceed 10% of the LEL. This figure is in line with general industry standards and the requirements of the United Kingdom Health & Safety Executive (Information Document HSE 703/13 "Application of Surface Coatings to Ship's Tanks") and the United States Department of Labor Occupational Safety and Health Administration (OSHA) regulation 1915.36(a)(2).

The ventilation requirement can be calculated from the required air quantity (RAQ) to 10% of the LEL figures and the product application rate. A typical paint application rate by airless spray is 75-100 litres (19.7-26.3 U.S. Gallons) per hour per sprayer.

Venting to 10% of the LEL is considered to provide a reasonable margin of safety to allow for possible higher local concentrations due to the complex geometry of ballast tanks. Nevertheless, care should be taken when setting up ventilation/extraction systems, to ensure that 10% figure is not exceeded.

If the level of ventilation is reduced during coating application, in order to minimise possible dry spray, the paint application rate must also be reduced to ensure that solvent vapour levels remain below 10% of the LEL.

Responsibility rests with the shipyard/contractor to ensure that the requisite equipment is available and operated in such a way that these requirements are met. International Paint will provide all of the information needed to allow the shipyard/contractor to calculate ventilation requirements. However, International Paint does not accept responsibility for the equipment, its operation, or the monitoring necessary to ensure that the requisite ventilation requirements are met.

All equipment used after the commencement of paint application must be electrically safe in operation.

Provision must be made by the contractor/shipyard for continuous, round the clock, surveillance of ventilation equipment.

5.5 DEHUMIDIFICATION

Dehumidification equipment, when required, must be of adequate capacity to maintain the condition of blasted steelwork to the required standard. Additionally, in order to prevent condensation, the steel temperature must always be at least 5°F (3°C) above the dew point.

Coatings may only be applied to surfaces which have been maintained in a dry condition with the steel temperature at least 5°F (3°C) above the dew point for more than one hour. The surfaces must be visibly dry and clean at the time of application. This condition must be maintained until the coating is cured.

Tank Coating must only be undertaken under acceptable atmospheric conditions, otherwise adverse effects may occur.

Provision should be made for 24 hour surveillance of equipment..

5.6 HEATING

If heating is necessary to satisfy the painting specification, it should be by means of a heat exchange system, i.e. air admitted to the tank should not pass directly through a combustion chamber.

Temperatures should be maintained for the duration of the contract from application to cure and provision should be made for 24 hour surveillance of equipment by the contractor/shipyard.

5.7 LIGHTING

Lighting during blasting and painting must be electrically safe and provide suitable illumination for all work. As a guide, lighting may be considered suitable if this text can be read at a distance of 12 inches from the eye.

Ideally, the lighting should be powerful mains supplied spotlight with background lighting on at all times in the interests of safety.

Powerful mains spotlighting must be provided when inspection work is being carried out.

5.8 STORAGE (AT POINT OF APPLICATION)

The paint must be stored out of direct sunlight so that the temperature of the material will not exceed 90°F (32°C) for prolonged periods of time.

The base and curing agent must be stored in premises (storeroom, hut, etc), which are maintained at a temperature between 70-80°F (21-26°C) for at least 48 hours prior to use.

5.9 GRIT BLASTING

5.9.1 General

Two main universal standards of surface preparation are normally specified for ballast tank coatings - ISO Standard ISO 8501-1 (2007) - Sa2½ and Sa3.

In general, the following comments apply to these standards.

Sa2½ - in practice, this is considered to be the best standard a skilled blasting operative can consistently achieve.

Sa3 - the possibility of achieving a uniform standard of Sa3 throughout the tanks is remote and a more realistic achievement would be somewhere between Sa2½ and Sa3.

Comparative Standards

<u>ISO 8501-1: 2007</u>	<u>Japanese Standard on new steel</u>	<u>SSPC Standard</u>
Sa2½	JA SH2	SSPC-SP10
Sa3	JA SH3	SSPC-SP5

Additionally, International Paint has identified acceptable limits of sweep blasting shop primers which may be specified after consultation with International Paint.

Pictorial representations are available; see International Paint "Abrasive Sweep Standards - For Shop Primed Steel Surfaces (Edition 3)"

In cases where the substrate is corroded or pitted, it may be necessary to fresh water wash the areas after abrasive blasting, then re-blast, in order to ensure complete removal of soluble corrosion products.

5.9.2 Compressed Air

Air used for blasting must be clean, oil free and dry. The pressure should be at least 7kg/cm² (100lb/sq inch) at the nozzle.

5.9.3 Abrasive

Abrasives used for blasting must be dry and free from dirt, oil, grease and suitable for producing the standard of cleanliness and profile specified. The abrasive must therefore be in accordance with the specifications given in ISO 11126 - Parts 1 to 8 and each delivery should carry a certificate of conformity to this specification.

If blasting abrasive is supplied on site without a certificate of conformity, the material should be tested by the yard or contractor in accordance with the methods given in ISO 11127 - Parts 1 to 7.

Particular attention should be given to ISO 11127 - Part 6, where the level of water soluble contaminants must not give a conductivity value greater than 25mS/m, and ISO 11127 - Part 7, where the level of water soluble chlorides must not exceed 0.0025% by weight.

Iron or steel abrasives can be used for in-situ open blasting. Specifications for metallic abrasives are given in ISO 11124 - Parts 1 to 4 and the corresponding test methods in ISO 11125 - Parts 1 to 7. If used, careful and thorough cleaning must be carried out at all stages of the operation to ensure that no abrasive remains in the tank as this may subsequently corrode.

Although not recommended, recycled grit may be used providing it is dry, has been shown to be free from contamination by dirt, oil, grease, and has been tested in accordance with the above ISO standards.

5.9.4 Blast Profile

The amplitude of the blast profile depends upon the type of coating to be applied, measurement on site should be by profile gauge or other instruments mutually acceptable.

Measurement of surface profile using comparators is described in ASTM D4417 Method A and a value of 2 - 4 mils (50-100 microns) is acceptable.

Measurement of surface profile using a needle gauge is described in ASTM D4417 Method B and an average value in the range 3 – 4 mils (75-100 microns), taking a maximum of 10 determinations, is acceptable.

Measurement of surface profile using replica tape is described in ASTM D4417 Method C and NACE RP0287-91.

5.10 CLEANING

Prior to initial blasting inspection, the bulk of spent grit must be removed.

Any substandard areas should be identified and must be brought up to the specified standard.

All marking paint, chalk, etc, used to identify substandard areas must be removed after substandard areas are rectified. If marking pens are used which cannot be removed then they must be technically approved by the International Paint Worldwide Marine Laboratories prior to any overcoating taking place.

Following provisional approval of the blast standard, all remaining traces of grit and dust must be removed from all areas including scaffolding, using industrial vacuum cleaners fitted with brushes, or by other suitable methods agreed by International. The quantity of dust remaining should be no greater than Pictorial reference 1 : ISO 8502-3 and be of no greater size than Class 2 : ISO 8502-3.

Final approval of a substrate for coating application must be confirmed after final cleaning.

Mats for wiping feet, (or overshoes), should be placed at the entrance of tanks, and the area immediately surrounding them kept in a clean condition.

5.11 PAINT APPLICATION

Interline 783 should be applied by plural component airless spray – consult International Paint Representative.

Efficient mechanical stirrers for the correct mixing of paint must be used.

All spray equipment must be in good working order and be capable of performing to the output requirements defined in International Paint product technical data sheets.

Both during and following application of paint, all operatives entering the confines of coated tanks must wear soft soled shoes.

Plural Feed application

The following equipment set-up should be used as a guide to apply Interline 783 through plural feed equipment

Pump	Standard commercially available plural component airless spray equipment with minimum pump ratio 47:1. Mixing ratio set at 3:1 v/v.
Spray lines	It is recommended that a 1/2" internal diameter paint hose is used for the base component line, and a 3/8" internal diameter paint line for the curing agent. This helps balance the flow through the lines, as the viscosity of the base component is higher than that of the curing agent. The paint hose carrying mixed paint should be 3/8" maximum internal diameter.
Tip sizes	A tip orifice size of between 15 and 19 thousandths is may be used. Although 15 thou may appear low for application of a high build product, it has been shown to give excellent coverage and film thickness control. The higher spray pressures ensure that the volume throughput is sufficient so that a typical number of passes are required to achieve the recommended wft. A 15 thou tip will also give the optimum spray fan, and is therefore recommended for use.
Pressure/Paint	Recommended pump pressure range between 3,000 – 3,500 psi and product
Temperature	temperature should be between 70-90°F (21-32°C); before feeding to paint lines. It is also recommended that paint line length should not exceed 150 feet past the mixing block. For best application control the recommended tip size range is 15 - 19 thousandths. For large open surfaces a 21 thousandths tip size may be used (note this will yield a heavier spray pattern and may be more difficult to control wet mils). Mixing ratios must be verified prior to application and hoppers must be monitored to prevent cavitations of the spray system as this may result in incorrect mixing ratios.
Application	Mixed material will cure rapidly in paint lines. If spraying is to be stopped for more than 10 minutes, lines with mixed paint in should be flushed with solvent.
Cleaning	The following International thinners are recommended for cleaning spray equipment: GTA415, GTA840 or GTA407. Sufficient volumes of cleaning solvent should be used to ensure that all paint residues are flushed out of the paint lines.

5.12 STRIPE COATS

Stripe coating is an essential part of good painting practice.

Due to the short pot-life of Interline 783, it is difficult to apply stripe coats by brush or roller. For this reason, Interline 783 stripe coats is recommended to be applied using plural feed airless spray, with a narrow fan angle tip. In some difficult to reach areas (e.g. scallops), application by airless spray may not be possible. In these circumstances, other application methods, such as by brush, will be necessary – please consult the International Paint representative for additional information.

Other paints may be used for stripe coating, please consult the International Paint representative for additional information.

Typical areas where stripe coats must be applied include:

- behind bars
- plate edges
- cut outs i.e. scallops, manholes etc
- welds
- areas of difficult access
- ladders and handrails
- small fitments of difficult configuration
- areas of pitting

Note: The above list is not comprehensive, all areas must be included. The diagrams following indicate key areas requiring stripe coating:

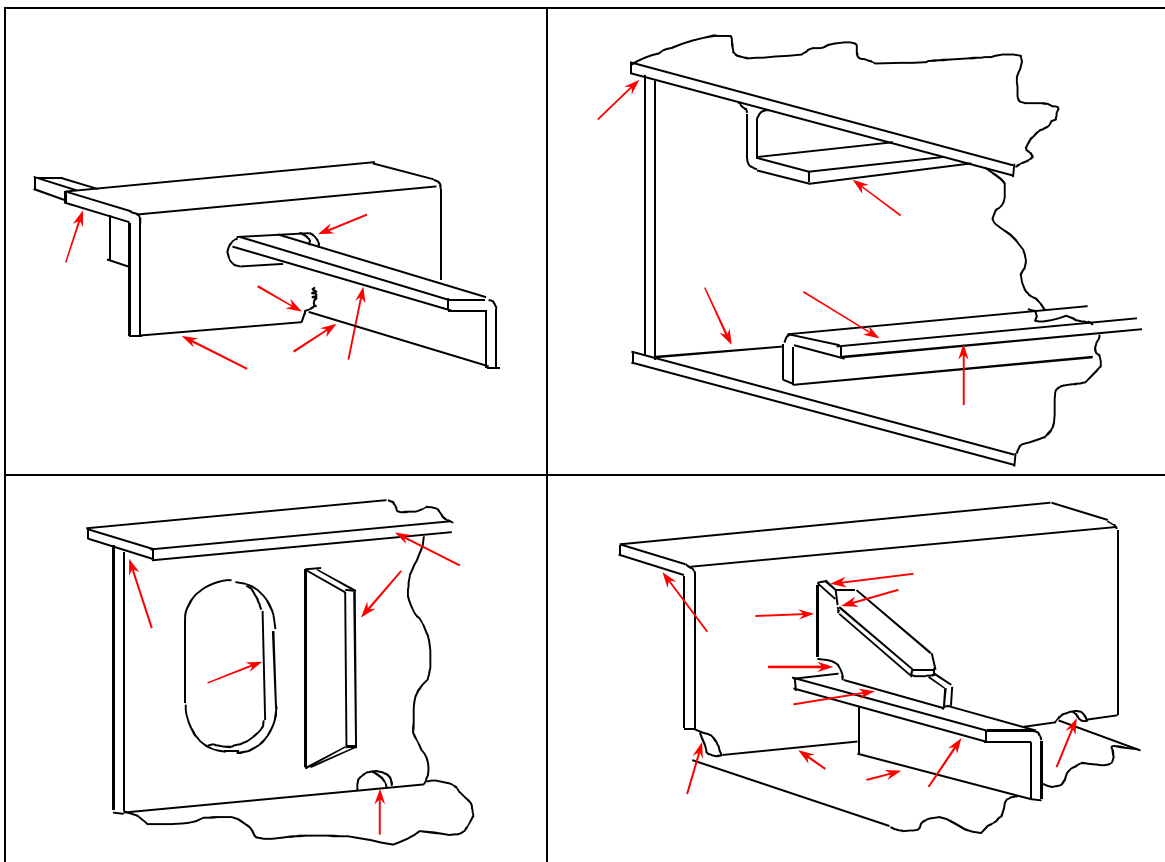

5.13 ADHESION TESTING

In order to detect any problems regarding adhesion of the coating system, either between coats or to the underlying steel, at the earliest possible stage, and to prevent subsequent problems later in the building process, adhesion assessment should be carried out at block stage. This assessment must be carried out by the International Paint Technical Service Representative.

Adhesion tests should be carried out as follows on one area of good ventilation and one area of restricted ventilation on each block, e.g. an edge open to the air and an area that would be expected to have little air movement. Stripe coated areas should be avoided unless the coating scheme is "one-shot".

- a) Once the coating scheme has hardened sufficiently, using a sharp penknife, preferably of the Swiss Army type, make a "V" cut in the coating penetrating to steel:

30-45°



- b) At the apex of the "V", use the knife to determine if the individual coats can be **cleanly** separated. If there is no clean separation, the weakest point in the system is cohesively within the coating and this does not give rise to adhesion problems.
- c) Rate the intercoat adhesion according to the system shown overleaf.
- d) Record all details of the test results. These records **MUST** be retained by the Local International Paint Technical Service Manager. Also record the adhesion of the coating system to the steel substrate.

Application Guidelines

Interline® 783

Revision 7 Date 10th April 2015



Coating adhesion rating system

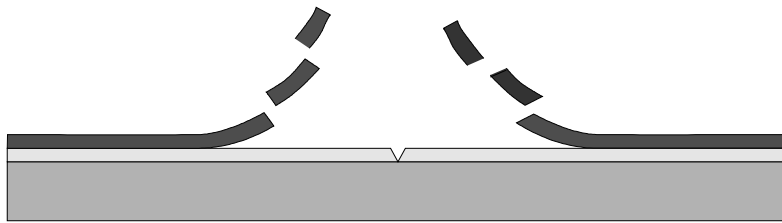

0 = No adhesion
No force required to split coatings.
(Backs of flakes - Clean)

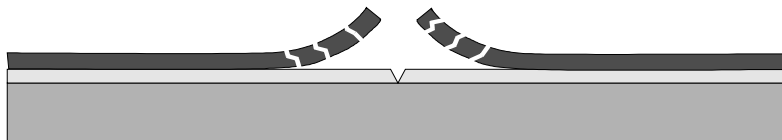

1 = Very poor adhesion
Little force required to split coatings.
(Backs of flakes - Clean)

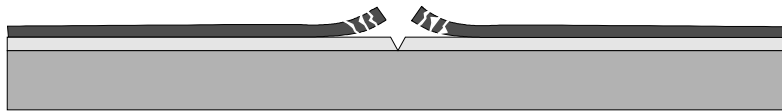

2 = Poor adhesion
(Backs of flakes - Clean)

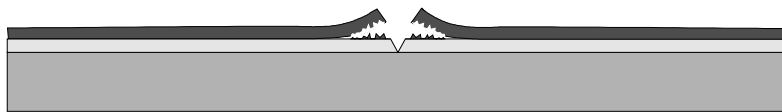

3 = Fair adhesion
(Backs of flakes show 'bits' of each coating)



4 = Good adhesion

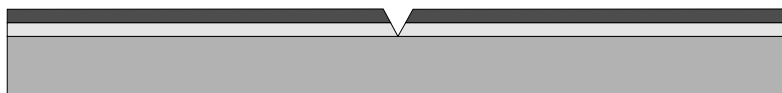

5 = Excellent adhesion



Substrate



First coat



Second coat

Marine Coatings

All products supplied and technical advice or recommendations given are subject to our standard Conditions of Sale.

Registered in England No. 63604

Registered Office 26th Floor, Portland House, Bressenden Place, London SW1E 5BG



6. REPAIR PROCEDURES

6.1 INTRODUCTION

These repair procedures are recommended for damages either at the initial coating stage or where breakdown of coating has occurred during the service life of the vessel.

The repair procedure recommended will depend upon the extent of damage involved but can be split into:

- i) Repairs of major areas
- ii) Repairs of minor areas

6.2 MAJOR REPAIRS

A Major repair should essentially be dealt with as if the project were beginning. The recommendations given earlier for steel preparation, coating application, etc. MUST all be adhered to.

6.3 MINOR REPAIRS

Under this heading are repairs to areas damaged either at the initial coating stage, i.e. caused by de-staging, etc or caused during service, i.e. tank cleaning equipment damages, spot corrosion, etc. The principle requirements are:

The area to be repaired must be fresh water washed and dry.

Remove any corrosion by means of either:

- vacuum blasting
- water jetting to the appropriate International Paint Hydroblasting Standard (refer to product data sheet)
- hand tools, i.e. disc sander and grinder.

Any pittings which, in the opinion of the Classification Society, do not need re-welding, should be prepared by needle gun and/or cone shaped grinder to remove corrosion deposits.

It is not normally recommended to use filler in pittings as it is likely to detach, taking with it any paint which has subsequently been applied, thus exposing the steelwork to possible further corrosion.

If however, it is decided to use filler, it must be applied after the first coat of the system, then overcoated with the remaining coats.

Abrade area immediately surrounding repair to provide key for subsequent paint application.

Apply the paint system in accordance with the recommendations of International Paint. If small areas are involved and application is by brush, several coats may be required to achieve the correct dry film thickness.

Cure time - when minor repairs have been carried out the cure time can be reduced to 75% of that recommended for full tank applications.

7. HEALTH & SAFETY

7.1 INTRODUCTION

Some ballast tank coatings contain volatile flammable organic solvents which can form explosive mixtures with air. Definite safety precautions must be taken whilst applying this type of coating in the confines of a ship's ballast tank. Detailed attention must be given to the following points:

- Danger of explosion or fire.
- Provision of a suitable breathing environment for workers.
- Prevention of skin irritation problems.
- Use of paints which have been specially formulated for use in ballast tanks.

7.2 DANGER OF EXPLOSION OR FIRE

The key factors in preventing an explosion or fire are:

- Adequate ventilation.
- Elimination of naked flames, sparks and any ignition sources.

Any organic solvent based coating could, merely by the normal process of drying, give off sufficient solvent vapour to produce an explosive mixture in a tank when the vapour concentration reaches or exceeds 1% by volume in air. However, at 1% the solvents in the coatings produce an unpleasant odour, (often with irritating skin effects) and smarting of the eyes. These symptoms must be taken as a warning sign that better ventilation is needed. 0.1% solvent vapour in air is normally recommended to give a tenfold safety margin and at this concentration, no explosion can occur and no operator effects should be noticed.

7.3 VENTILATION

(Note: This must be read in conjunction with General Note 5.4).

Ventilation is necessary during abrasive blasting operations to ensure adequate visibility. Flexible trunking should be used to allow the point of extraction to be reasonably close to the personnel carrying out the blasting.

During and after coating application it is essential that solvent vapours are removed to ensure that the level present in the atmosphere does not rise above that recommended in the section (7.2) dealing with "Danger of Explosion and Fire". This means that the ventilation system must be arranged such that "dead spaces" do not exist and the ventilation must be continued both during the time that application is proceeding and also whilst solvent is released from the paint film during the drying process. Particular care must be taken to ensure that solvent vapour, which is heavier than air, does not accumulate in the lower areas of the tanks.

The amount of air per minute for ventilating to 10% of the LEL (lower explosive limit) can be regarded as the required air quantity multiplied by rate of application per minute. The required air quantity is the amount of air needed for each litre of paint to ventilate to the required level.

RAQ = Required Air Quantity
LEL = Low Explosive Limit

Ventilation required (m³/minute) = RAQ x the application rate (litres/minute). The likely approximate application rate can be calculated from figures available from the application equipment supplier and will depend on the airless spray pump pressure and the orifice size of the tip used.

The geometry and size of tanks makes each one a separate problem, and it is essential that the ventilation arrangement, fan type, etc is checked as being suitable before painting commences.

Wing tanks, double bottoms and double skinned vessels require special attention. Because of their construction, adequate ventilation is difficult and rapid build-up of solvent vapour and explosive concentrations may occur. It is recommended that, when workers are involved in such spaces, a careful check is kept to ensure that they are not in difficulty and that there is supervised continuity of essential services such as air and electricity.

In the event of a failure of the extraction/ventilation system paint application must be stopped and the tanks evacuated of personnel immediately.

7.4 ELIMINATION OF IGNITION SOURCES

Safety is the overriding consideration with this type of tank coating work, and the Contractor and Crew must be made fully aware of all aspects of the operation.

Welding, cutting or grinding in the tank must be forbidden until paint fumes are totally ventilated. This also applies to all areas within a 20m (60 feet) radius of tank and trunking outlets.

Coamings and hatch openings must be covered so as to efficiently prevent spark entry where welding is being carried out on the superstructure.

Lights, including hand torches, must be certified by the manufacturer as flash proof and suitable for use in solvent laden atmospheres.

Smoking must be prohibited in or near tanks or extraction systems.

No electrical junction boxes should be allowed in tanks.

Airless spray equipment must be earthed (because of the danger of static electricity build-up)

Mobile telephones, electrical cameras, and any equipment that is not intrinsically safe, must not be used in or near tanks or extraction systems until paint fumes are totally dispersed.

7.5 SOLVENT VAPOUR AND PAINT MISTS - PROTECTION OF PAINTING PERSONNEL

No ventilation system can reduce solvent vapour levels to below the Occupational Exposure Limit for solvents whilst tank coating is in operation. Painters must, therefore, wear air fed hoods or pressure fed masks with additional eye protection. (Please note: air fed hoods which provide a curtain of air across the visor are available. These help to prevent settlement of spray mist on the visor). Normal protective clothing must be worn, e.g. overalls, gloves, and suitable footwear of non-spark type.

7.6 SKIN IRRITATION

If proper protective clothing has been worn, e.g. overalls, gloves, air fed hood, etc no discomfort should be experienced from skin irritation. Any small areas not protected by clothing, e.g. wrists or neck, can be treated with a non-greasy barrier cream. (Petroleum jelly is not recommended as this can assist the transport of solvents into the skin).

Any areas of skin accidentally contaminated with paint must be thoroughly washed with soap and water. A skin conditioner that is designed to replace the natural oils in the skin can be used.

Note

1. The preceding safety information is given for guidance only.
2. It is imperative that, prior to the commencement of any tank coating project, local Regulations regarding Health and Safety be consulted.

All representations and statements concerning the product(s) in this publication are accurate to the best of our knowledge. Statements made in this publication are advisory only and are not intended to be specific recommendations or warranties of any product, combination of products or fitness for any particular purpose. To the extent permitted by law, we do not accept any liability to any person for any loss or damage (direct or indirect) that may arise from any use or reliance on any of the methods or information contained in this publication for any purpose.

Unless otherwise agreed in writing, all products supplied and technical advice or recommendations given are subject to the Conditions of Sale of our supplying company. Any warranties, if given, are contained in those standard Conditions of Sale and are the only ones made with respect to any products we sell to your or advice or recommendations we give to you.

We hereby disclaim any warranties or representations, expressed or implied, by operation of law or otherwise, including, without limitation, any implied warranty of merchantability or fitness for a particular purpose.

For each of our products the relevant Product Data Sheet, Material Safety Data Sheet and package labelling comprise an integral information system about the product in question. Copies of our Product Data Sheets and Material Safety Data Sheets are available on request or from our website: www.international-marine.com.

 **International** and all product names mentioned in this publication are trademarks of, or licensed to, Akzo Nobel.

Marine Coatings

All products supplied and technical advice or recommendations given are subject to our standard Conditions of Sale.

