

# **APPLICATION GUIDELINES**

## **BALLAST TANKS**

**Intergard<sup>®</sup> 7600**

**Revision 6**

**Issue Date: 4<sup>th</sup> July 2017**

<b><u>CONTENTS</u></b>	<b><u>Page</u></b>
1. <a href="#">SCOPE AND PURPOSE</a>	3
2. <a href="#">PRODUCT SPECIFICATION AND PRODUCT CURE GRAPHS</a>	4
2.1 <a href="#">Surface Preparation</a>	4
2.2 <a href="#">Specification</a>	4
2.3 <a href="#">Film Thickness</a>	5
2.4 <a href="#">Holding-Primer (For Use at Major Refurbishment Only)</a>	5
2.5 <a href="#">Notes</a>	5
2.6 <a href="#">Product Cure Graphs</a>	6
3. <a href="#">COATING APPLICATION PROCEDURES</a>	8
4. <a href="#">TECHNICAL INSPECTION AND PROJECT CONTROL</a>	13
5. <a href="#">GENERAL NOTES</a>	14
5.1 <a href="#">Tank condition</a>	14
5.2 <a href="#">Steelwork Preparation</a>	15
5.3 <a href="#">Scaffolding</a>	16
5.4 <a href="#">Ventilation</a>	16
5.5 <a href="#">Dehumidification</a>	17
5.6 <a href="#">Heating</a>	17
5.7 <a href="#">Lighting</a>	18
5.8 <a href="#">Storage at point of application</a>	18
5.9 <a href="#">Grit Blasting</a>	18
5.10 <a href="#">Water Jetting (Hydroblasting) at Major Refurbishment</a>	20
5.11 <a href="#">Cleaning</a>	21
5.12 <a href="#">Paint Application</a>	21
5.13 <a href="#">Stripe Coats</a>	22
5.14 <a href="#">Water Testing</a>	23
6. <a href="#">REPAIR PROCEDURES</a>	24
7. <a href="#">HEALTH &amp; SAFETY</a>	25

### 1. SCOPE AND PURPOSE

The International Paint Ballast Tank Coating Application Guidelines are produced and revised in accordance with the Worldwide Marine product range and IMO PSPC MSC.215(82) for Water Ballast Tanks and Double-skin spaces. The purpose of the guidelines is to ensure that a coating system, when correctly applied, provides the necessary protection against corrosion.

Successful in-service performance of a ballast tank coating system depends upon both the correct choice of coating and the adoption of the correct procedures for surface preparation and paint application.

This document provides guidance to the specialised field of ballast tank coating application. It is the result of experience gained by International Paint during the application of sophisticated ballast tank coatings to over 10,100 vessels since 1960, and the requirements for compliance with IMO PSPC MSC.215(82) for Water Ballast Tanks and Double Side-Skin Spaces of Bulk Carriers.

The responsibilities for achieving the specific standards outlined and for carrying out surface preparation and paint application rest with the Contracting Company and Shipyard. Under no circumstances do these responsibilities rest with International Paint. We will generally provide for the presence of a Technical Service Representative at key stages during the performance of the contract. The role of the International Paint Technical Service Representative is advisory only, unless otherwise specified in the terms and conditions of the contract.

## 2. PRODUCT SPECIFICATION AND PRODUCT CURE GRAPHS

### 2.1 SURFACE PREPARATION

#### 2.1.1 Newbuilding

Intact approved shop primer must be cleaned by sweep abrasive blasting or high pressure fresh water washing. Block construction welds, areas of corrosion and damages to the shop primer must be abrasive blasted to Sa2<sup>1/2</sup> (ISO 8501-1:2007).

Non approved shop primers must be completely removed by abrasive blasting to Sa2<sup>1/2</sup> (ISO 8501-1:2007). In some cases abrasive blasting to Sa2 (ISO 8501-1:2007), removing at least 70% of the intact primer, may be acceptable. (Consult International Paint for advice on specific shop primers). However, where this applies, block construction welds, areas of corrosion and shop primer damage must be abrasive blasted to Sa2<sup>1/2</sup> (ISO 8501-1:2007).

#### 2.1.2 Major Refurbishment

Grit blast to a minimum of Sa2 (ISO 8501-1:2007) or prepare by water jetting to International Paint Hydroblasting standard HB2M. If oxidation has occurred between grit blasting and application of Intergard 7600, the surface should be reblasted to the specified visual standard. Surface defects revealed by the blast cleaning process, should be ground, filled or treated in the appropriate manner.

#### 2.1.3 Application

Airless spray, brush, roller

### 2.2 SPECIFICATION

For IMO PSPC MSC.215(82) Compliant Newbuilding Projects

<u>Coat</u>	<u>Product</u>	<u>Colour</u>	<u>Dft (microns)</u>	<u>Dft (mils)</u>
Full	Intergard 7600	Red aluminium	160	6.3
Stripe	Intergard 7600	Grey		
Stripe	Intergard 7600	Red aluminium		
Full	Intergard 7600	Grey	160	6.3

For non IMO PSPC MSC.215(82) Projects

	<u>Coat</u>	<u>Product</u>	<u>Colour</u>	<u>Dft (microns)</u>	<u>Dft (mils)</u>
<b>(i)</b>	Full	Intergard 7600	Red aluminium	150	5.9
	Stripe	Intergard 7600	Grey		
	Stripe	Intergard 7600	Red aluminium		
	Full	Intergard 7600	Grey	150	5.9
<b>Or</b> <b>(i)</b>	Full	Intergard 7600	Red aluminium	125	4.9
	Stripe	Intergard 7600	Grey		
	Stripe	Intergard 7600	Red aluminium		
	Full	Intergard 7600	Grey	125	4.9

**Note:** KUA760-Red aluminium must always be the first coat.

### 2.3 FILM THICKNESS

#### Maximum Film Thickness

Dry film thicknesses should be kept below 960 microns where practical (i.e. three times the specified system thickness). Where excessive overlapping is unavoidable on e.g. corners, or where erection joint line coating is overlapping onto coating applied at the block coating stage, occasional thicknesses up to 2000 microns may be expected. International Paint must be consulted when other than a small number of film thickness readings fall outside of this range.

#### Minimum Film Thickness

The specified scheme dry film thickness of 320 microns must be achieved on at least 90% of the total coated surface area. A minimum dry film thickness, equivalent to 90% of that specified, must be achieved on the remaining 10%.

For further information, consult International Paint.

### 2.4 HOLDING-PRIMER (FOR USE AT MAJOR REFURBISHMENT ONLY)

Intergard 269, applied at 40 microns (1.57 mils) dft, may also be applied as a holding primer if required. Dry film thickness should not exceed 60 microns (2.36 mils) and addition of thinner may be necessary in order to achieve close control of film thickness. Refer to technical datasheet for thinner recommendations and overcoating intervals.

### 2.5 NOTES

- 2.5.1 Refer to the accompanying graphs for recommended overcoating intervals, pot life and curing requirements.
- 2.5.2 The drying times quoted refer to a single coat applied to give 160 microns (6.3 mils) dry film thickness. At higher film thicknesses drying times may be extended, particularly at low temperature.
- 2.5.3 Touch up of damages caused during destaging is to be done by brush with Intergard 7600 to a nominal dry film thickness of 320 microns (12.6 mils). Minimum and maximum dft as stated in Section 2.3 will apply.
- 2.5.4 In accordance with IMO PSPC MSC.215(82) at Newbuilding, all thicknesses are to be checked under the supervision of the nominated Coatings Inspector. Any substandard areas are to be rectified.
- 2.5.5 For application the steel temperature must not be lower than -5°C (23°F).
- 2.5.6 For optimum application properties, steel temperature should not exceed 50°C (122°F) during application. Application at higher temperatures may be possible – consult your local International Paint representative.
- 2.5.7 Areas of overspray are to be sanded down prior to overcoating.

# Application Guidelines

## Intergard® 7600

Revision 6 Date 4<sup>th</sup> July 2017



### 2.6 PRODUCT CURE GRAPHS

- 2.6.1 Pot Life
- 2.6.2 Touch Dry Times
- 2.6.3 Hard Dry Times
- 2.6.4 Times to Ballast
- 2.6.5 Minimum Overcoating Intervals
- 2.6.6 Maximum Overcoating Intervals

#### Pot Life

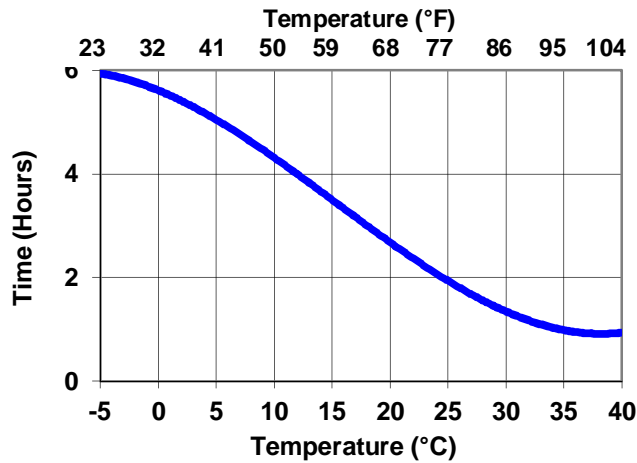

#### Touch Dry

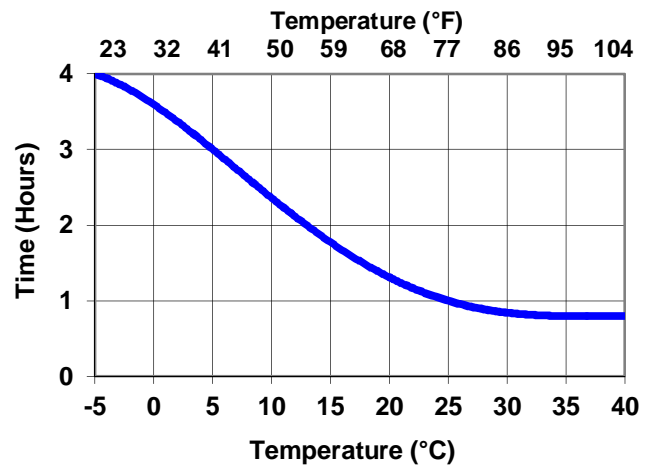

#### Hard Dry

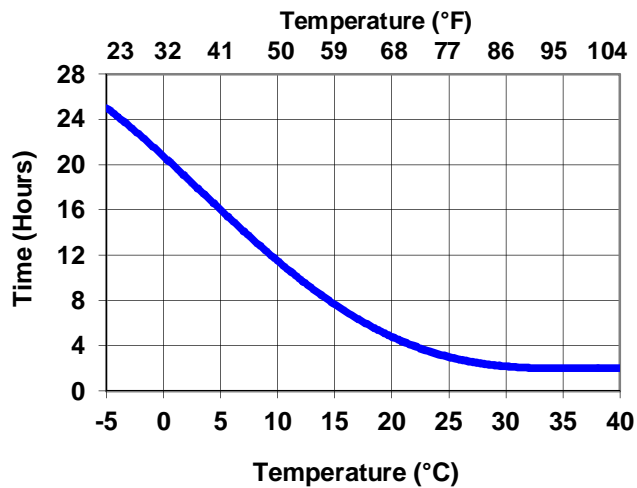

#### Time to Ballast

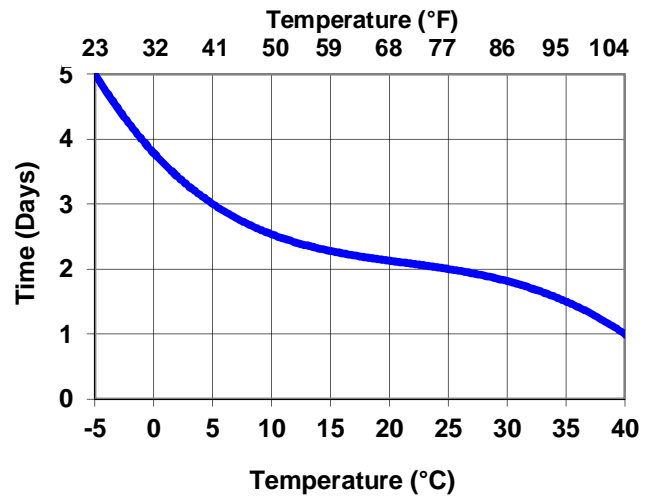

## Marine Coatings

All products supplied and technical advice or recommendations given are subject to our standard Conditions of Sale.



# Application Guidelines Intergard® 7600

Revision 6 Date 4<sup>th</sup> July 2017



## Minimum Overcoating

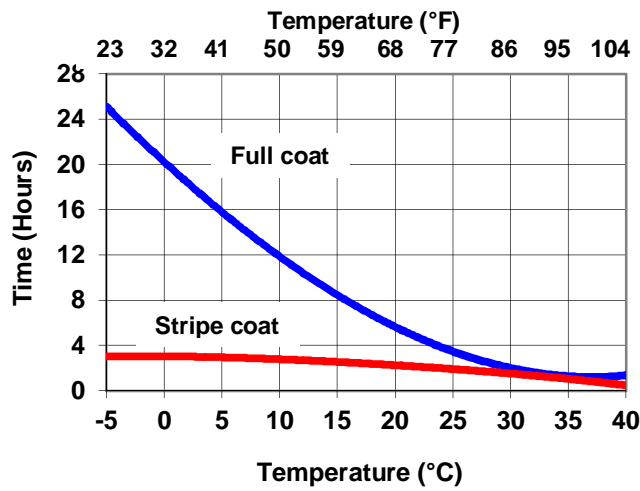

## Maximum Overcoating

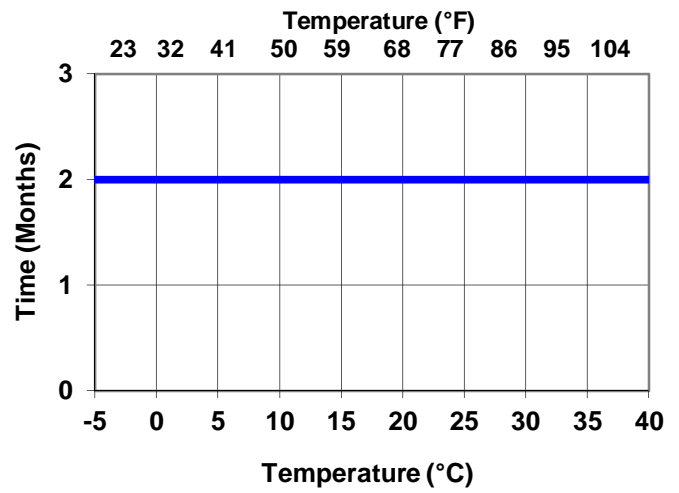

## Marine Coatings

All products supplied and technical advice or recommendations given are subject to our standard Conditions of Sale.



### 3. COATING APPLICATION PROCEDURES

#### 3.1 FOR IN-SITU NEWBUILDING APPLICATIONS

- 3.1.1 Where necessary, remove weld spatter, smooth weld seams and remove sharp edges by rounding to a minimum radius of 2mm or subjecting to a “three pass” grinding technique.
- 3.1.2 All surfaces must be clean, dry and free from contamination. High pressure fresh water wash or fresh water wash, as appropriate and remove all oil, grease, soluble contaminants and other foreign matter in accordance with SSPC-SP1 : solvent cleaning.
- 3.1.3 Intact approved shop primer must be cleaned by sweep abrasive blasting or high pressure fresh water washing. Block construction welds, areas of corrosion and damages to the shop primer must be abrasive blasted to Sa2<sup>1</sup>/<sub>2</sub> (ISO 8501-1:2007)
- 3.1.4 Shop primers which have not passed the IMO PSPC MSC.215(82) pre-qualification testing and are not certified for use with Intergard 7600 must be removed by abrasive blasting to Sa2 (ISO 8501-1:2007), removing at least 70% of the intact primer. (Consult International Paint for advice on specific shop primers). However, where this applies, block construction welds, areas of corrosion and shop primer damage must be abrasive blasted to Sa2<sup>1</sup>/<sub>2</sub> (ISO 8501-1:2007).
- 3.1.5 Upon completion of the blasting, and after inspection by the Contractor Quality Control Department, the International Paint Technical Service Representative will also inspect the whole area and mark up any substandard areas.
- 3.1.6 All marked areas shall be brought up to the specified standard of preparation. The whole blasted area is to be vacuum cleaned to remove dust and contamination.
- 3.1.7 Levels of substrate salt contamination should be determined as outlined in section 3.4 of this procedure.
- 3.1.8 Residual dust levels should be determined prior to paint application and must not exceed rating “1” for dust size classes “3”, “4” or “5”. (ISO 8502-3:1993). Lower dust class sizes to be removed if visible on the surface to be coated without magnification.
- 3.1.9 Apply the coating scheme as specified in section 2.2 of this procedure. Observe the specified, maximum and minimum dry film thickness.

Stripe coats should be applied to areas itemised in section 5.13 of this procedure.

When hard dry, each full coat and each stripe coat is to be inspected by the International Paint Technical Service Representative.

Prior to application of subsequent coats, ensure surfaces are clean and dry after stripe coating and inspection procedures.

- 3.1.10 Once the full system has been applied, and has been accepted by the Contractor Quality Control Department, the International Paint Technical Service Representative will check the dry film thickness.
- 3.1.11 Any areas of under thickness are to be brought up to the minimum thickness specified. International Paint must be consulted when other than a small number of film thickness readings are above the max allowable - see Section 2.3.



- 3.1.12 It is recommended that completed tanks are “water tested” to highlight any pinholes or mechanical damages in the tank coating that are difficult to detect by normal visual inspection. Any defective areas identified are to be repaired in accordance with the recommendations of the International Paint Technical Service representative. Refer to section 5.14 for details.

### 3.2 FOR NEWBUILDING APPLICATIONS AT BLOCK STAGE

#### At Block Stage

- 3.2.1 Where necessary, remove weld spatter, smooth weld seams and remove sharp edges by rounding to a minimum radius of 2mm or subjecting to a “three pass” grinding technique.
- 3.2.2 All surfaces must be clean, dry and free from contamination. High pressure fresh water wash or fresh water wash, as appropriate and remove all oil, grease, soluble contaminants and other foreign matter in accordance with SSPC-SP1 : solvent cleaning.
- 3.2.3 Intact approved shop primer must be cleaned by sweep abrasive blasting or high pressure fresh water washing. Block construction welds, areas of corrosion and damages to the shop primer must be abrasive blasted to Sa2<sup>1</sup>/<sub>2</sub> (ISO 8501-1:2007)
- 3.2.4 Shop primers which have not passed the IMO PSPC MSC.215(82) pre-qualification testing and are not certified for use with Intergard 7600 must be removed by abrasive blasting to Sa2 (ISO 8501-1:2007), removing at least 70% of the intact primer. (Consult International Paint for advice on specific shop primers). However, where this applies, block construction welds, areas of corrosion and shop primer damage must be abrasive blasted to Sa2<sup>1</sup>/<sub>2</sub> (ISO 8501-1:2007).
- 3.2.5 Upon completion of the blasting, and after inspection by the Contractor Quality Control Department, the International Paint Technical Service Representative will also inspect the whole area and mark up any substandard areas.
- 3.2.6 All marked areas shall be brought up to the specified standard of preparation. The whole blasted area is to be vacuum cleaned to remove dust and contamination.
- 3.2.7 Levels of substrate salt contamination should be determined as outlined in section 3.4 of this procedure.
- 3.2.8 Residual dust levels should be determined prior to paint application and must not exceed rating “1” for dust size classes “3”, “4” or “5”. (ISO 8502-3:1993). Lower dust class sizes to be removed if visible on the surface to be coated without magnification.
- 3.2.9 Apply the coating scheme as specified in section 2.2 of this procedure. Observe the specified, maximum and minimum dry film thickness.
- Stripe coats should be applied to areas itemised in section 5.13 of this procedure.
- When hard dry, each full coat and each stripe coat is to be inspected by the International Paint Technical Service Representative.
- Prior to application of subsequent coats, ensure surfaces are clean and dry after stripe coating and inspection procedures.
- 3.2.10 Once the full system has been applied, and has been accepted by the Contractor Quality Control Department, the International Paint Technical Service Representative will check the dry film thickness.

- 3.2.11 Any areas of under thickness are to be brought up to the minimum thickness specified. International Paint must be consulted when other than a small number of film thickness readings are above the max allowable - see Section 2.3.

### **After Erection**

- 3.2.12 Ensure the surfaces to be painted are clean, dry and free of all contamination.
- 3.2.13 Erection joint welds and adjacent areas must be abrasive blasted to Sa2<sup>1/2</sup> (ISO 8501-1:2007) or power tooled to St3 (ISO 8501-1:2007). Where power tool preparation is used, and in order to ensure satisfactory adhesion of the Intergard 7600 system, care should be taken to avoid "polishing" the welds and surrounding areas.
- 3.2.14 Small damages, up to 2% of the total area, may be prepared by power tooling to St3 (ISO 8501-1/2:2007).
- 3.2.15 Areas of neighbouring damages over 25m<sup>2</sup>, or damages which constitute an area of over 2% of the total tank surface area must be abrasive blasted to Sa2<sup>1/2</sup> (ISO 8501-1:2007).
- 3.2.16 Ensure surfaces are clean and free from debris.
- 3.2.17 To these areas, apply the coating scheme as specified in section 2.2 of this procedure, feathering on overlap areas. Observe the specified, maximum and minimum dry film thickness.

Stripe coats should be applied to areas itemised in section 5.13 of this procedure.

When hard dry, each full coat and each stripe coat is to be inspected by the International Paint Technical Service Representative.

Prior to application of subsequent coats, ensure surfaces are clean and dry after stripe coating and inspection procedures.

- 3.2.18 Once the full system has been applied, and has been accepted by the Contractor Quality Control Department, the International Paint Technical Service Representative will check the dry film thickness.
- 3.2.19 Any areas of under thickness are to be brought up to the minimum thickness specified. This must be carried out within the overcoating limits specified for the product. International Paint must be consulted when other than a small number of film thickness readings are above the max allowable - see Section 2.3.
- 3.2.20 It is recommended that completed tanks are "water tested" to highlight any pinholes or mechanical damages in the tank coating that are difficult to detect by normal visual inspection. Any defective areas identified are to be repaired in accordance with the recommendations of the International Paint Technical Service representative. Refer to section 5.14 for details.

### 3.3 FOR APPLICATIONS AT MAJOR REFURBISHMENT

- 3.3.1 For any new steel fitted during refurbishment, remove weld spatter and grind sharp edges and uneven welds until smooth.
- 3.3.2 Fresh water wash to remove all dirt and contamination as necessary. Degrease area according to SSPC-SP1 solvent cleaning.
- 3.3.3 Grit blast the entire tank to ISO Standard ISO 8501-1 (2007) - Sa2 minimum.
- 3.3.4 Upon completion of the blasting, and after inspection by the Contractor Quality Control Department, the International Paint Technical Service Representative will also inspect the whole area and mark up any substandard areas.
- 3.3.5 All marked areas shall be brought up to the specified standard of preparation. The whole blasted area is to be vacuum cleaned to remove dust and contamination.
- 3.3.6 Apply the coating scheme as specified in section 2.2 of this procedure. Observe the specified, maximum and minimum dry film thickness.

Stripe coats should be applied to areas itemised in section 5.13 of this procedure.

When hard dry, each full coat and each stripe coat is to be inspected by the International Paint Technical Service Representative.

Prior to application of subsequent coats, ensure surfaces are clean and dry after stripe coating and inspection procedures.

- 3.3.7 Once the full system has been applied, and has been accepted by the Contractor Quality Control Department, the International Paint Technical Service Representative will check the dry film thickness.
- 3.3.8 Any areas of under thickness are to be brought up to the minimum thickness specified.
- 3.3.9 It is recommended that completed tanks are "water tested" to highlight any pinholes or mechanical damages in the tank coating that are difficult to detect by normal visual inspection. Any defective areas identified are to be repaired in accordance with the recommendations of the International Paint Technical Service representative. Refer to section 5.14 for details.

### 3.4 MEASUREMENT OF SALT CONTAMINATION PRIOR TO COATING

The procedure below can be used in conjunction with the above application procedures.

- 3.4.1 Prior to coating the prepared (e.g. gritblasted) surface, measure the amount of residual salt using the Bresle patch method (ISO 8502-6: 1995 "Extraction of soluble contaminants for analysis – The Bresle method" / ISO 8502-9: 1998 "Field method for the conductimetric determination of water-soluble salts") or similar. These methods are also described in Module No.8 of the International Paint Technical Service training programme. The number of tests to be carried out will depend upon the size of the area and should be agreed before the contract begins.
- 3.4.2 If the result is less than or equivalent to 50mg/m<sup>2</sup> painting can proceed.
- 3.4.3 If the result is greater than 50mg/m<sup>2</sup> the area should be fresh water washed and, when dry, the salt contamination level re-measured.
- 3.4.4 This washing process is to be repeated until the level is less than or equal to 50mg/m<sup>2</sup>.
- 3.4.5 The entire area should then be re-blasted to the specified standard and the salt contamination measurement process (3.4) repeated.

### 4. TECHNICAL INSPECTION AND PROJECT CONTROL

Project control by regular inspection and agreement on future action is vital to successful tank coating projects, and in maximising the potential of a coating system.

All parties involved in the ballast tank coating work must agree an inspection procedure prior to work commencing, this should outline how and when both work and inspection will be undertaken.

Prior to commencing the project the contractor(s) must be provided with copies of the relevant product data sheets. Attention should be drawn to pack sizes, mix ratios, thinning restrictions etc.

A series of standard forms are used by International Paint to monitor all tank and ballast coating projects. These are internal documents and do not replace the documents required for the coating file for IMO PSPC.

Daily meetings should be arranged to confirm performance of the work and inspection schedules, minutes of these meetings must be taken and circulated to all participants. Representatives of the contractor, shipyard and ship owner would normally be present at these meetings for major refurbishment applications.

At major refurbishment, and if International Paint are present during On Board maintenance application, in the event of work continuing at any stage without the approval of International Paint, the Company cannot be held responsible for any subsequent failure of the tank coating system on the areas concerned. Those areas **MUST** be specifically excluded from the performance guarantee. Such an event is termed an **EXCEPTION**. All parties **MUST** be officially informed in writing using the standard Exception Report Form immediately following the occurrence.

International Paint, and any other authorised personnel, may inspect any stage in the process. If additional inspections are considered necessary because of on site conditions or by agreement prior to commencement of the contract, then the contractor must obtain written approval for that stage from International Paint (if present) before continuing.

Contractors must supply interpreters if necessary.

On completion of the contract all relevant documentation must be retained, and safely archived, by the Contractor and the International Paint Technical Service Representative (if present).

Inspection equipment for measurement of blast profile depth, relative humidity, wet and dry film thickness, etc. should be of approved types and be correctly calibrated.

## **5. GENERAL NOTES**

### **5.1 TANK CONDITION**

#### **5.1.1 Newbuilding**

Prior to commencement of gritblasting it is essential that the tanks are clean, dry, and in a condition suitable for surface preparation and application of the tank coatings. The following briefly outlines the minimum requirements:

All grease and oil must be removed from all surfaces.

All hot work in way of tanks should be complete.

After final tank testing, tanks should be fresh water washed and dried, especially if they have been in contact with sea water.

Defective steelwork, prior to contract commencement, should be repaired in line with the guidance notes given in 5.2 (Steelwork Preparation).

#### **5.1.2 Major Refurbishment**

Prior to the commencement of blasting it is essential that the tanks are clean, dry, and in a condition suitable for surface preparation and application of tank coatings. The following briefly outlines the minimum requirements:

Tanks must be cleaned and gas free.

Any blisters present must be burst and blister caps removed from surface.

Heavy scale must be removed from all surfaces.

All grease and oil must be removed from all surfaces.

All hot work in way of tanks must be complete.

All tanks must be fresh water washed.

Any areas of steel renewal should be prepared in the manner described in 5.2 Steelwork Preparation

### 5.2 STEELWORK PREPARATION

The steel surface to be coated shall be prepared so that coating can achieve an even distribution at the required NDFT and have an adequate adhesion by removing sharp edges, grinding weld beads and removing weld spatter and any other surface contaminant to grade P2

Edges to be treated to a rounded radius of minimum 2mm, or subjected to three pass grading or at least equivalent process before painting - Refer to standard ISO 8501-3: 2001. Preparation of steel substrate before application of paints and related products - Visual assessment of surface cleanliness

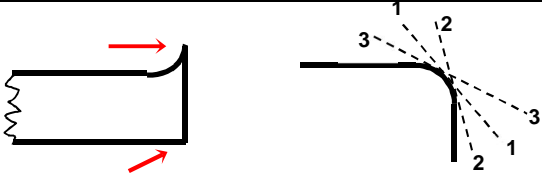
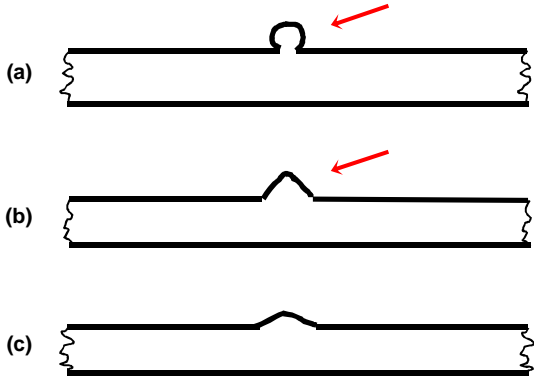
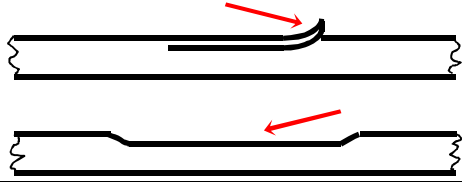
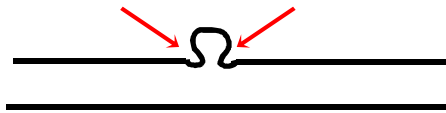
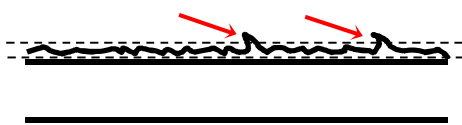
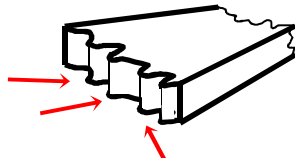
ITEM	PROBLEM / SOLUTION
Sharp Edge	<p>Edges should be treated to a rounded radius of minimum 2mm, or subjected to three pass grinding or equivalent.</p> 
Weld Spatter	<ol style="list-style-type: none"> <li>1. Remove spatter observed before blasting by grinder, chipping hammer etc.</li> <li>2. For spatter observed after blasting: <ol style="list-style-type: none"> <li>a) Remove with chipping hammer /scraper etc.</li> <li>b) Where spatter is sharp, use disc sander or grinder until obtuse</li> <li>c) Obtuse spatter – no treatment required</li> </ol> </li> </ol> 
Plate Lamination	<p>Any lamination to be removed by grinder or disc sander</p> 
Undercut	<p>Where undercut is to a depth exceeding 1mm and a width smaller than the depth, repair by welding or grinding may be necessary</p> 
Manual Weld	<p>For welding bead with surface irregularity or with excessive sharp edges, remove by disc sander or grinder</p> 
Gas Cut Surface	<p>For surfaces of excessive irregularity, remove by disc sander or grinder</p> 

### 5.3 SCAFFOLDING

Tubular scaffolding must not mask surfaces to be coated. Where contact is necessary then spade ends should be used.

Staging must afford easy and safe access to all surfaces to be coated and should be between 15cm and 30cm (6 and 12 inches) from vertical surfaces which are to be coated.

Tubular scaffolding must be plugged or capped prior to grit blasting to prevent the ingress of grit and dirt.

Staging should be designed to allow thorough cleaning. Where scaffolding is wooden, International Paint recommend that staging be of the 'turn over' type, when local safety regulations permit.

Distance between staging levels should not exceed 2 metres (6 feet).

If fixed staging lugs are fitted, these should be stainless steel.

Staging layout should be such that ventilation is not rendered ineffective.

Care must be taken when removing scaffolding in order to keep damages to a minimum. Any damages should be repaired in accordance with the recommendations of International Paint's representative on site.

### 5.4 VENTILATION

Ventilation is necessary during abrasive blasting operations to ensure adequate visibility. Flexible trunking should be used to allow the point of extraction to be reasonably close to the personnel carrying out the blasting.

During and after coating application the ventilation system and trunking must be so arranged such that "dead spaces" do not exist. As solvent vapours are heavier than air, and will tend to accumulate in the lower areas of tanks, it is important that they are extracted from those areas. This must be balanced with fresh air being introduced into the tank.

Equipment used must not re-introduce abrasive dust, solvent vapour etc. into the tank. For this reason a positive pressure, above normal atmospheric pressure, should be maintained inside the tank. As a "rule of thumb" fresh air supply/extraction should be in the approximate ratio of 4:3.

Ventilation must be maintained during application and continue whilst solvent is released from the paint film during drying. Failure to do this may result in solvent retention within the coating system that will adversely affect it's long term performance. It must be maintained for a minimum period of 48 hours after coating application has been completed unless otherwise agreed with International Paint.

The level of ventilation employed must take account of the Lower Explosive Limit (LEL) of the product being applied and comply with local legislative requirements. (The LEL is the minimum concentration of vapour in air, expressed as a percentage, that will ignite). International Paint recommend that this is such that vapour concentrations do not exceed 10% of the LEL. This figure is in line with general industry standards and the requirements of the United Kingdom Health & Safety Executive (Information Document HSE 703/13 "Application of Surface Coatings to Ship's Tanks") and the United States Department of Labor Occupational Safety and Health Administration (OSHA) regulation 1915.36(a)(2).



The ventilation requirement can be calculated from the required air quantity (RAQ) to 10% of the LEL figures and the product application rate. A typical paint application rate by airless spray is 75-100 litres (19.7-26.3 U.S. Gallons) per hour per sprayer.

Venting to 10% of the LEL is considered to provide a reasonable margin of safety to allow for possible higher local concentrations due to the complex geometry of ballast tanks. Nevertheless, care should be taken when setting up ventilation/extraction systems, to ensure that 10% figure is not exceeded.

If the level of ventilation is reduced during coating application, in order to minimise possible dry spray, the paint application rate must also be reduced to ensure that solvent vapour levels remain below 10% of the LEL.

Responsibility rests with the shipyard/contractor to ensure that the requisite equipment is available and operated in such a way that these requirements are met. International Paint will provide all of the information needed to allow the shipyard/contractor to calculate ventilation requirements. However, International Paint does not accept responsibility for the equipment, its operation, or the monitoring necessary to ensure that the requisite ventilation requirements are met.

All equipment used after the commencement of paint application must be electrically safe in operation.

Provision must be made by the contractor/shipyard for continuous, round the clock, surveillance of ventilation equipment.

### 5.5 DEHUMIDIFICATION

Dehumidification equipment, when required, must be of adequate capacity to maintain the condition of blasted steelwork to the required standard. Additionally, in order to prevent condensation, the steel temperature must always be at least 3°C (5°F) above the dew point.

Coatings may only be applied to surfaces which have been maintained in a dry condition with the steel temperature at least 3°C (5°F) above the dew point for more than one hour. The surfaces must be visibly dry and clean at the time of application. This condition must be maintained until the coating is cured.

Tank Coating must only be undertaken under acceptable atmospheric conditions, otherwise adverse effects may occur.

As a guide, relative humidity levels of 40-60% give optimum results. Application should not take place if the relative humidity is greater than 85%.

Provision should be made for 24-hour surveillance of equipment.

### 5.6 HEATING

If heating is necessary to satisfy the painting specification, it should be by means of a heat exchange system, i.e. air admitted to the tank should not pass directly through a combustion chamber.

Temperatures should be maintained for the duration of the contract from application to cure and provision should be made for 24-hour surveillance of equipment.

### 5.7 LIGHTING

Lighting during blasting and painting must be electrically safe and provide suitable illumination for all work. As a guide, lighting may be considered suitable if this text can be read at a distance of 30 centimetres (12 inches) from the eye.

Ideally, the lighting should be powerful mains supplied spotlight with background lighting on at all times in the interests of safety.

Powerful mains spotlighting must be provided for inspection work.

### 5.8 STORAGE (AT POINT OF APPLICATION)

The paint must be stored out of direct sunlight so that the temperature of the material will not exceed 35°C (95°F) for prolonged periods of time.

In winter months, when temperatures can be expected to fall below 5°C (41°F), base and curing agent must be stored in premises, (storeroom, hut, etc), which are heated to a temperature in excess of 5°C (41°F) for a period of not less than 48 hours immediately prior to use (unless stated otherwise on the product technical data sheet).

### 5.9 GRIT BLASTING

#### 5.9.1 General

The universal standards of surface preparation that are normally specified for ballast tank coatings are - ISO Standard ISO 8501-1 (2007) – Sa2, Sa2½ and Sa3.

In general, the following comments apply to these standards.

Sa2 - the resulting steel surface should be free from most of the rust, old coating and foreign matter. Any residual old coating should be firmly adhering -

Sa2½ - in practice, this is considered to be the best standard a skilled blasting operative can consistently achieve.

Sa3 - the possibility of achieving a uniform standard of Sa3 throughout the tanks is remote and a more realistic achievement would be somewhere between Sa2½ and Sa3.

#### Comparative Standards

<u>ISO 8501-1: 2007</u>	<u>Japanese Standard on new steel</u>	<u>SSPC Standard</u>
Sa2	Not applicable	SSPC-SP6
Sa2½	JA SH2	SSPC-SP10
Sa3	JA SH3	SSPC-SP5

Additionally, International Paint has identified acceptable limits of sweep blasting shop primers which may be specified after consultation with International Paint.

International Paint Abrasive Sweep Standards for Shop Primed Steel Surfaces provides pictorial representations. AS2 represents removal of 70% intact shop primer and as such can be used to obtain the required surface preparation standard for removal of intact non approved shop primers for IMO PSPC MSC.215(82) projects.

In cases where the substrate is corroded or pitted, it may be necessary to fresh water wash the areas after abrasive blasting, then re-blast, in order to ensure complete removal of soluble corrosion products.

Residual dust levels should be determined prior to paint application and must not exceed rating "1" for dust size classes "3", "4" or "5". (ISO 8502-3:1993). Lower dust class sizes to be removed if visible on the surface to be coated without magnification.

### **5.9.2 Compressed Air**

Air used for blasting must be clean, oil free and dry. The pressure should be at least 7kg/cm<sup>2</sup> (100lb/sq inch) at the nozzle.

### **5.9.3 Abrasive**

Abrasives used for blasting must be dry and free from dirt, oil, grease and suitable for producing the standard of cleanliness and profile specified. The abrasive must therefore be in accordance with the specifications given in ISO 11126 - Parts 1 to 8 and each delivery should carry a certificate of conformity to this specification.

If blasting abrasive is supplied on site without a certificate of conformity, the material should be tested by the yard or contractor in accordance with the methods given in ISO 11127 - Parts 1 to 7.

Particular attention should be given to ISO 11127 - Part 6, where the level of water soluble contaminants must not give a conductivity value greater than 25mS/m, and ISO 11127 - Part 7, where the level of water soluble chlorides must not exceed 0.0025% by weight.

Iron or steel abrasives can be used for in-situ open blasting. Specifications for metallic abrasives are given in ISO 11124 - Parts 1 to 4 and the corresponding test methods in ISO 11125 - Parts 1 to 7. If used, careful and thorough cleaning must be carried out at all stages of the operation to ensure that no abrasive remains in the tank as this may subsequently corrode.

Although not recommended, recycled grit may be used providing it is dry, has been shown to be free from contamination by dirt, oil, grease, and has been tested in accordance with the above ISO standards.

### **5.9.4 Blast Profile**

For IMO PSPC applications measurement of surface profile should be carried out using comparators, specifications for which are described in ISO 8503-1 and procedure for use in ISO 8503-2. A blast profile of 30-75 microns is required.

For non-PSPC applications, the required amplitude of the blast profile depends upon the type of coating to be applied and should be measured using a surface profile gauge or other mutually accepted instruments, such as:

- Replica tape (ASTM D4417-C, ISO 8503-5), which tends to give a maximum rather than mean value.
- Comparators (ISO 8503-1/2).
- Stylus (ISO 8503-4).

As surface profile results by these methods may not be comparable, all parties should agree on the instrument to be used. When using comparators, a medium 'G' type should be used and a value of 50-100 microns is acceptable. When using a needle type profile gauge, the needle may not reach to the full depth of the profile "valley" and an average value in the range 75-100 microns, taking a maximum of 10 determinations, is acceptable.

ISO 8503-3 describes the measurement of surface profile by the use of focusing microscope, however this is impractical for use in the field.

### 5.10 WATER JETTING (HYDROBLASTING) AT MAJOR REFURBISHMENT

All GRP ballast pipes and vulnerable fittings are to be suitably protected with masking prior to water jetting.

Only fresh water is to be used for water jetting. Salt water is unacceptable for substrate preparation. Chemical corrosion inhibitors must **not** be added to blasting water. See note 5.6 of the International Paint Hydroblasting Standards.

All areas are to be prepared by water jetting to a minimum standard of HB2 'Thorough Hydroblast Cleaning' from the International Paint Hydroblasting Standards. This states:

"When viewed without magnification, the surface shall be free from visible oil, grease, dirt and from most of the rust, paint coatings and foreign matter. Any remaining contamination and staining shall be firmly adhered. See notes 5.9 and 5.10".

A test area will be blasted before the main tank, and inspected before flash rusting has occurred. See note 5.3 of the International Paint Hydroblasting Standards. Agreement will be reached by the Owner's representative, the International Paint representative (if present) and the Contractor's representative on the agreed standard before the main tank area is prepared by water jetting.

Areas such as the edges of 'mouse holes' and scallops will be very difficult to water jet. It is advisable to mechanically clean these areas to ISO 8501-1-1988 - St3 after water jetting.

Areas of difficult access such as the backs of bulbous bars may also be difficult to blast with water jet lances. At the discretion of the Owner and the International Paint representative (if present), these areas may also be mechanically cleaned to ISO 8501-1-1988 - St3.

Islands of intact paint will only be allowed to remain by agreement with all parties, Owners, International Paint (if present) and Contractor. The surface of intact paint will be scoured by water jetting to produce a 'keyed' surface suitable for overcoating, and edges will be feathered back from a firm edge.

Rust, scale and old paint debris must be removed from the tank prior to inspection and mark-up by the Contractor's Quality Control Department. The International Paint representative (if present) will then inspect the whole area and mark up any substandard areas.

All marked areas shall be reblasted and brought up to the required standard. This standard is International Paint Hydroblasting Standard HB2M 'Moderate Flash Rusting', which states:

"When viewed without magnification, a layer of light tan-brown rust will obscure the original metallic surface. This layer may be evenly distributed or patchy in appearance, but it will be heavy enough to mark objects brushed against it".

If flash rusting is too heavy, it can be removed by high pressure washing. Upon drying, the surface must have an acceptable level of flash rusting for overcoating. See note 5.7 from the International Paint Hydroblasting Standards.

Surface salt contamination should be measured (See section 3.4). The maximum permissible level is 50mg/m<sup>2</sup>.

### 5.11 CLEANING

Prior to initial blasting inspection, the bulk of spent grit (and old paint debris if water jetting) must be removed.

Any substandard areas should be identified and must be brought up to the specified standard.

All marking paint, chalk, etc, used to identify substandard areas must be removed after substandard areas are rectified. If marking pens are used which cannot be removed then they must be technically approved by the International Paint Worldwide Marine Laboratories prior to any overcoating taking place.

Following provisional approval of the blast standard, all remaining traces of grit and dust must be removed from all areas including scaffolding, using industrial vacuum cleaners fitted with brushes, or by other suitable methods agreed by International Paint.

Final approval of a substrate for coating application must be confirmed after final cleaning.

Mats for wiping feet, (or overshoes), should be placed at the entrance of tanks, and the area immediately surrounding them kept in a clean condition.

### 5.12 PAINT APPLICATION

All paints should be applied by airless spray except for stripe coats where brush or roller should in general be used.

Efficient mechanical stirrers for the correct mixing of paint must be used.

Available air pressure and capacity for spray equipment should be at least 5.5kg/cm<sup>2</sup> and 1.4m<sup>3</sup>/min (80 psi and 50 cfm).

All spray equipment must be in good working order and be capable of performing to the output requirements defined in International Paint product technical data sheets.

It is recommended that airless spray pump ratios of 40:1 or greater should be used.

Tips should be the size stipulated on the product technical data sheet, or as agreed with the International Paint representative on site. Tips must not be in a worn condition.

Both during and following application of paint, all operatives entering the confines of coated tanks must wear soft-soled shoes or overshoes.

### 5.13 STRIPE COATS

Stripe coating is an essential part of good painting practice. Typical areas where stripe coats must be applied include:

- behind bars
- plate edges
- cut outs i.e. scallops, manholes etc
- welds
- areas of difficult access
- ladders and handrails
- small fittings of difficult configuration
- areas of pitting

Note: The above list is not comprehensive, all areas must be included. The diagrams following indicate key areas requiring stripe coating:

In general, stripe coats should be applied by brush or roller, depending upon items concerned.

In exceptional circumstances it may be acceptable to apply a stripe coat to the backs of angle bars by narrow angle spray. The use of spray applied stripe coats however, must be discussed and agreed with the International Paint representative on site.

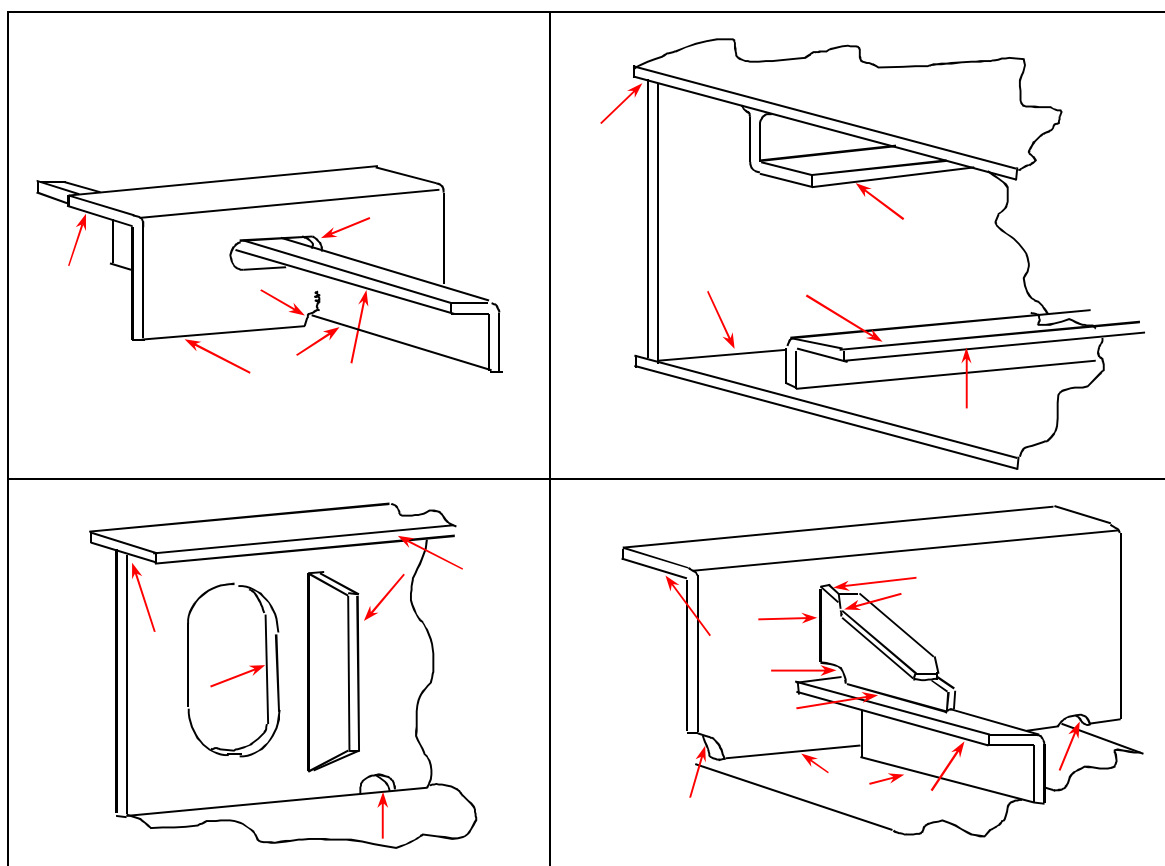

### 5.14 WATER TESTING

Often, in order to identify any defects in the applied coating system (e.g. mechanical damages or pinholes that are difficult to detect by normal visual inspection), water testing of tanks is carried out. However, in those shipyards where International Paint's knowledge and experience of local working and quality assurance procedures is such that undetected coating damages will not normally occur, water testing is not mandatory and an alternative, mutually agreed, method of inspection may be employed. International Paint should be consulted where clarification of this latter point is required.

In other shipyards, or on projects where the mode of operation will not allow post-delivery inspection/repair (e.g. operational FPSO's), it is recommended that completed tanks are "water tested" to highlight any pinholes or mechanical damages in the tank coating.

Testing, which may use fresh, brackish or sea water, is carried out as follows:

- a) Prior to carrying out the test, the coating must be allowed to cure. The time between completion of coating application and commencing the test is dependant on both the type of coating and the substrate temperature and is given in the "time to ballast" graph in section 2.5 of this procedure.
- b) Ballast the tank for a period of at least 24 hours.
- c) After de-ballasting, and if necessary to remove silt etc., wash the tank thoroughly.
- d) Inspect the tank for any defective areas and repair in accordance with the recommendations of the International Paint Technical Service Representative. Prior to repair, the defective areas must be thoroughly washed with fresh water.

Final acceptance of the tanks will not normally take place until water testing and subsequent touch up repairs have been carried out to the satisfaction of International Paint.

## 6. REPAIR PROCEDURES

### 6.1 INTRODUCTION

These repair procedures are recommended for damages either at the initial coating stage or where breakdown of coating has occurred during the service life of the vessel.

The repair procedure recommended will depend upon the extent of damage involved but can be split into:

- i) Repairs of major areas
- ii) Repairs of minor areas

### 6.2 MAJOR REPAIRS

A Major repair should essentially be dealt with as if the project were beginning. The recommendations given earlier for steel preparation, coating application, etc. MUST all be adhered to.

### 6.3 MINOR REPAIRS

Under this heading are repairs to areas damaged either at the initial coating stage, i.e. caused by de-staging, etc or caused during service, i.e. tank cleaning equipment damages, spot corrosion, etc. The principle requirements are:

The area to be repaired must be fresh water washed and dry.

Remove any corrosion by means of either:

- vacuum blasting
- water jetting to the appropriate International Paint Hydroblasting Standard (refer to product data sheet)
- hand tools, i.e. disc sander and grinder.

Any pittings which, in the opinion of the Classification Society, do not need re-welding, should be prepared by needle gun and/or cone shaped grinder to remove corrosion deposits.

It is not normally recommended to use filler in pittings as it is likely to detach, taking with it any paint which has subsequently been applied, thus exposing the steelwork to possible further corrosion.

If however, it is decided to use filler, it must be applied after the first coat of the system, then overcoated with the remaining coats.

Abrade area immediately surrounding repair to provide key for subsequent paint application.

Apply the paint system in accordance with our recommendations. If small areas are involved and application is by brush, several coats may be required to achieve the correct dry film thickness.

Cure time - when minor repairs have been carried out the cure time can be reduced to 75% of that recommended for full tank applications.



## 7. HEALTH & SAFETY

### 7.1 INTRODUCTION

Some ballast tank coatings contain volatile flammable organic solvents which can form explosive mixtures with air. Definite safety precautions must be taken whilst applying this type of coating in the confines of ship's ballast tanks.

Detailed attention must be given to the following points:

- Danger of explosion or fire.
- Provision of a suitable breathing environment for workers.
- Prevention of skin irritation problems.
- Use of paints which have been specially formulated for use in ballast tanks.

### 7.2 DANGER OF EXPLOSION OR FIRE

The key factors in preventing an explosion or fire are:

- Adequate ventilation.
- Elimination of naked flames, sparks and any ignition sources.

Any organic solvent based coating could, merely by the normal process of drying, give off sufficient solvent vapour to produce an explosive mixture in a tank when the vapour concentration reaches or exceeds 1% by volume in air. However, at 1% the solvents in the coatings produce an unpleasant odour, (often with irritating skin effects) and smarting of the eyes. These symptoms must be taken as a warning sign that better ventilation is needed. 0.1% solvent vapour in air is normally recommended to give a tenfold safety margin and at this concentration, no explosion can occur and no operator effects should be noticed.

### 7.3 VENTILATION

(Note: This must be read in conjunction with General Note 5.4).

Ventilation is necessary during abrasive blasting operations to ensure adequate visibility. Flexible trunking should be used to allow the point of extraction to be reasonably close to the personnel carrying out the blasting.

During and after coating application it is essential that solvent vapours are removed to ensure that the level present in the atmosphere does not rise above that recommended in the section (7.2) dealing with "Danger of Explosion and Fire". This means that the ventilation system must be arranged such that "dead spaces" do not exist and the ventilation must be continued both during the time that application is proceeding and also whilst solvent is released from the paint film during the drying process. Particular care must be taken to ensure that solvent vapour, which is heavier than air, does not accumulate in the lower areas of the tanks.

The amount of air per minute for ventilating to 10% of the LEL (lower explosive limit) can be regarded as the required air quantity multiplied by rate of application per minute. The required air quantity is the amount of air needed for each litre of paint to ventilate to the required level.

RAQ = Required Air Quantity  
LEL = Low Explosive Limit

Ventilation required (m<sup>3</sup>/minute) = RAQ x the application rate (litres/minute). The likely approximate application rate can be calculated from figures available from the application equipment supplier and will depend on the airless spray pump pressure and the orifice size of the tip used.

The geometry and size of tanks makes each one a separate problem, and it is essential that the ventilation arrangement, fan type, etc is checked as being suitable before painting commences.

Wing tanks, double bottoms and double skinned vessels require special attention. Because of their construction, adequate ventilation is difficult and rapid build-up of solvent vapour and explosive concentrations may occur. It is recommended that, when workers are involved in such spaces, a careful check is kept to ensure that they are not in difficulty and that there is supervised continuity of essential services such as air and electricity.

In the event of a failure of the extraction/ventilation system paint application must be stopped and the tanks evacuated of personnel immediately.

### 7.4 **ELIMINATION OF IGNITION SOURCES**

Safety is the overriding consideration with this type of tank coating work, and the Contractor and Crew must be made fully aware of all aspects of the operation.

Welding, cutting or grinding in the tank must be forbidden until paint fumes are totally ventilated. This also applies to all areas within a 20m (60 feet) radius of tank and trunking outlets.

Coamings and hatch openings must be covered so as to efficiently prevent spark entry where welding is being carried out on the superstructure.

Lights, including hand torches, must be certified by the manufacturer as flash proof and suitable for use in solvent laden atmospheres.

Smoking must be prohibited in or near tanks or extraction systems.

No electrical junction boxes should be allowed in tanks.

Airless spray equipment must be earthed (because of the danger of static electricity build-up)

Mobile telephones, electrical cameras, and any equipment that is not intrinsically safe, must not be used in or near tanks or extraction systems until paint fumes are totally dispersed.

### 7.5 **SOLVENT VAPOUR AND PAINT MISTS - PROTECTION OF PAINTING PERSONNEL**

No ventilation system can reduce solvent vapour levels to below the Occupational Exposure Limit for solvents whilst tank coating is in operation. Painters must, therefore, wear air fed hoods or pressure fed masks with additional eye protection. (Please note: air fed hoods which provide a curtain of air across the visor are available. These help to prevent settlement of spray mist on the visor). Normal protective clothing must be worn, e.g. overalls, gloves, and suitable footwear of non-spark type.

### 7.6 SKIN IRRITATION

If proper protective clothing has been worn, e.g. overalls, gloves, air fed hood, etc no discomfort should be experienced from skin irritation. Any small areas not protected by clothing, e.g. wrists or neck, can be treated with a non-greasy barrier cream. (Petroleum jelly is not recommended as this can assist the transport of solvents into the skin).

Any areas of skin accidentally contaminated with paint must be thoroughly washed with soap and water. A skin conditioner that is designed to replace the natural oils in the skin can be used.

#### Note

1. The preceding safety information is given for guidance only.
2. It is imperative that, prior to the commencement of any tank coating project, local Regulations regarding Health and Safety be consulted.

*All representations and statements concerning the product(s) in this publication are accurate to the best of our knowledge. Statements made in this publication are advisory only and are not intended to be specific recommendations or warranties of any product, combination of products or fitness for any particular purpose. To the extent permitted by law, we do not accept any liability to any person for any loss or damage (direct or indirect) that may arise from any use or reliance on any of the methods or information contained in this publication for any purpose.*

*Unless otherwise agreed in writing, all products supplied and technical advice or recommendations given are subject to the Conditions of Sale of our supplying company. Any warranties, if given, are contained in those standard Conditions of Sale and are the only ones made with respect to any products we sell to your or advice or recommendations we give to you.*

*We hereby disclaim any warranties or representations, expressed or implied, by operation of law or otherwise, including, without limitation, any implied warranty of merchantability or fitness for a particular purpose.*

*For each of our products the relevant Product Data Sheet, Material Safety Data Sheet and package labelling comprise an integral information system about the product in question. Copies of our Product Data Sheets and Material Safety Data Sheets are available on request or from our website: [www.international-marine.com](http://www.international-marine.com).*

 and all product names mentioned in this publication are trademarks of, or licensed to, Akzo Nobel.

## Marine Coatings

All products supplied and technical advice or recommendations given are subject to our standard Conditions of Sale.

